



Part 8

BODY

P 120-series

CARS

**SERVICE
MANUAL**

CONTENTS

Description	1	Ventilation windows	13
P 120, 4-door	1	Removing and fitting	13
Body frame	1	Window winder with mechanism	14
Bonnet	2	Removing and fitting	14
Doors and openings	2	Sealing strips	15
Interior fittings and upholstery	3	Bonded strips	15
Front seats, late production	3	Strips attached with fastening rail	15
Rear seat	3	Luggage compartment lid, 2- and 4-door	16
Door upholstery	3	Tailgate, Station Wagon	17
Headlining	3	Upper tailgate	17
Covering for bulkhead and floor	3	Removing and fitting	17
Bumpers	3	Trim mouldings	18
P 120, 2-door	4	Waist mouldings	18
Body frame	4	Window mouldings	18
Bonnet	4	Removing	18
Doors and openings	4	Fitting	18
Interior fittings and upholstery	4	Moulding for rear side window,	
Front seats	4	Station Wagon	18
Other interior fittings	4	Trim mouldings, windscreen	20
P 120 Station Wagon	4	Removing	20
Body frame	4	Fitting	20
Doors and openings	6	Trim mouldings, rear window, 2- and 4-door	20
Interior fittings and upholstery	6	Removing	20
Front seats	6	Fitting	20
Rear seat	6	Windows	21
Bumpers	6	Windscreen	21
Repair instructions	7	Removing and fitting	21
Front end	7	Rear window	22
Front mudguards	7	Removing and fitting	22
Front section	7	Rear ventilation window, 2-door model ..	22
Bonnet and bonnet lock	7	Removing	22
Doors	8	Seats	23
Removing front door	8	Front seats	23
Removing rear door	8	Removing, early production	23
Removing door handles and upholstery ..	9	Removing, late production	23
Door locks and door handles	10	Adjusting	23
Removing door locks and lock handles	10	Rear seat, Station Wagon	23
Dismantling door handles	11	Removing the backrest	23
Fitting and adjusting locks	11	Removing lock mechanism for backrest ..	24
Front door	11	Upholstery	24
Rear door	12	Repairing inner roof (headlining)	24
Fitting and adjusting outer handles	13	Stretching headlining for removing	
Front door, early production	13	small holes at outer edge	24
Front door, late production	13	Replacing headlining	26
Rear door, late production	13	Instrument panel	27
Inner locking knob	13	Removing	27
Striker block	13		

DESCRIPTION

P 120, 4-DOOR

Body frame

The Volvo P 120 has an integral body so that there is no chassis frame. The body is composed of a number of pressed steel plates, each of which forms part of the supporting construction.

The body can be suitably divided up into the floor, side sections, rear section, scuttle, roof, front mudguards, doors, luggage compartment and bonnet. The floor and frame sections (Fig. 1) consist of a front and rear floor plate (1 and 4) and an inner cantrail (2), front and rear cross-members (8 and 6), tunnel (3) and scuttle (Fig. 2). The floor plates are welded together with the rear seat support. The tunnel (3), which accommodates the propeller shaft is spot-welded to the floor plates. The rear floor plate has a longitudinal reinforcing member (5) on each side at the bottom and between these a number of cross-members. One of the cross-members (6) is provided with an attachment (7) for the rear axle tie rod. There is a flanged hole in the rear floor plate for mounting the fuel tank, the upper

part of which forms part of the floor in the luggage compartment. The scuttle section (Fig. 2) consists of the bulkhead (7), wheel arches (5), front upper cross-member (4) and side plates (3), as well as lower cross-members (1 and 2). The bulkhead forms the front transverse wall of the body and is shaped with welded end pieces. Two front side members (8) project from the front floor. At the front they are joined together by means of a cross-member (2) and at the rear they are connected to the front cross-member under the front seats. Upper side members (6) project from the upper corner between the bulkhead and front pillar. These are spot welded to the front pillar, the front side plate and wheel arch plates. The front axle member and bumper support bars are attached to the side members.

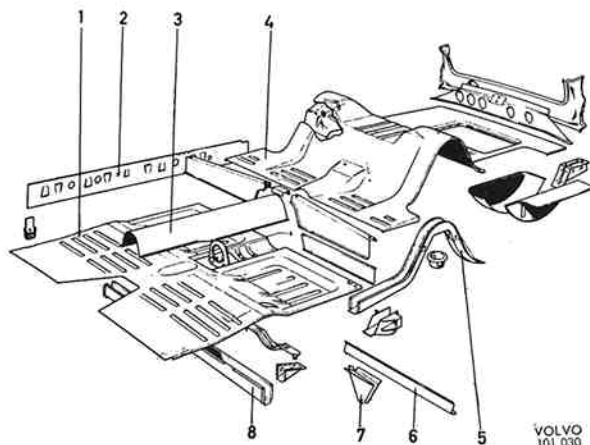

Fig. 1. Floor section (2- and 4-door)

- | | |
|-----------------------|-------------------------------------|
| 1. Front floor plate | 6. Rear cross-member |
| 2. Inner cantrail | 7. Attachment for rear axle tie rod |
| 3. Tunnel | 8. Front cross-member |
| 4. Rear floor plate | |
| 5. Reinforcing member | |

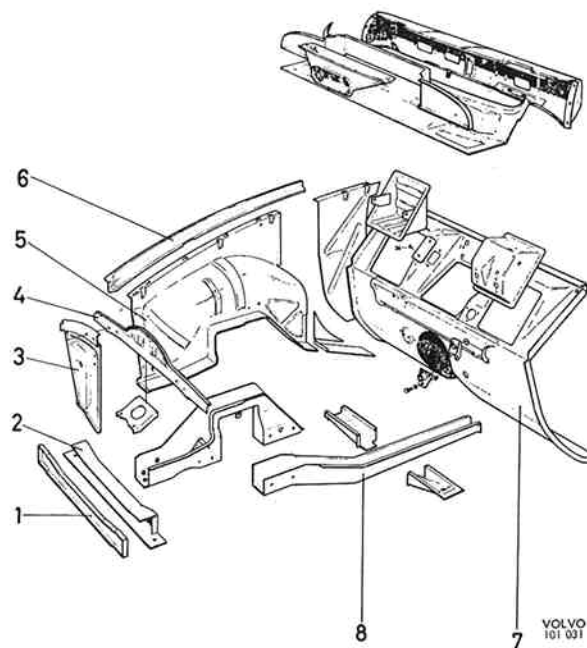

Fig. 2. Scuttle section

- | | |
|-----------------------------|-----------------------------|
| 1. Front lower cross-member | 4. Front upper cross-member |
| 2. Front lower cross-member | 5. Wheel arch |
| 3. Side plate | 6. Upper side member |
| | 7. Bulkhead |
| | 8. Front side member |

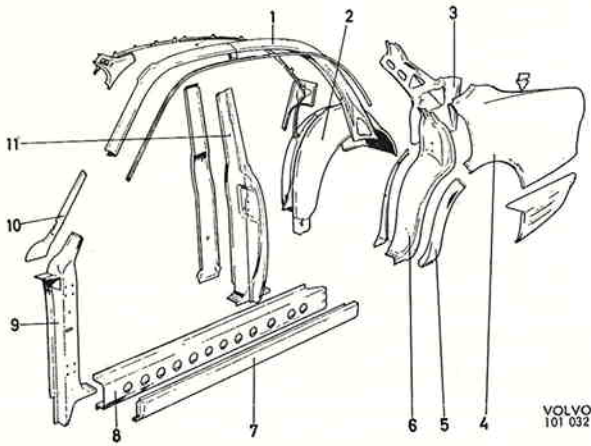

Fig. 3. Side section (4-door)

- | | |
|----------------------|--------------------------|
| 1. Roof former | 7. Outer cantrail |
| 2. Rear wheel arch | 8. Intermediate cantrail |
| 3. Joining plate | 9. Front pillar |
| 4. Rear mudguard | 10. Windscreen pillar |
| 5. Wheel arch member | 11. Intermediate pillar |
| 6. Rear pillar | |

On 4-door models the side section (Fig. 3) consists of the front pillar (9), intermediate pillar (11), rear pillar (6), intermediate and outer cantrails (8 and 7), roof former (1), windscreen pillar (10), rear wheel arch (2) with wheel arch member (5), rear mudguard (4), back plate and joining plate (3). The cantrail and wheel arch member are manufactured of galvanized sheet metal.

The roof section (Fig. 4) consists of a number of pressed steel plates. The roof plates form the upper part of the scuttle section, windscreen opening, the roof itself, the opening for the rear window and the upper limit of the luggage compartment. The front mudguards, front section and bonnet make up the front end.

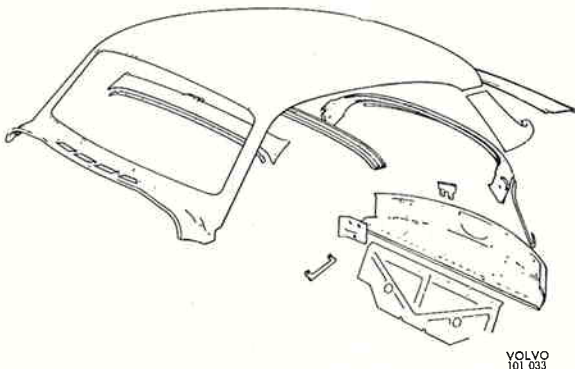

Fig. 4. Roof section (2- and 4-door)

The front end is bolted to the upper side members, front cross-member and front pillar. The front mudguards are pressed in one piece and bolted to the wheel arch plate. The front section forms the front part of the front end as well as the air duct to the radiator. The body is noise- and heat-insulated. The insulation consists of "waffle" board which is stuck on to the plate.

Bonnet

The bonnet is pivoted at the rear on two hinges. In the closed position, the bonnet is secured by a bonnet lock fitted on the front section. The lever for the bonnet lock is operated by means of a control placed underneath the dashboard inside the vehicle.

Doors and openings

The doors are built up of an outer and inner plate together with door arch which is flanged and spot-welded in one unit. The hinges are fitted to the inner plate. The doors are adjustable both longitudinally, vertically and laterally. The doors are provided with a door check. This consists of a flat bar attached to the door pillar and runs against a roller in the door. In the open position the flat bar obstructs the movement of the roller and thus limits the movement of the door. The door checks are fitted to the doors with screws. The press-button of the outside door handles operates a lever which in turn disengages a rotating toothed roller (tumbler). The inside door handles are fitted to the remote control which is attached to the inner door plate with screws. The handle transmits the movement to the toothed roller by means of a link rod. The lock insert is fitted in the press-button on the door handle. The doors can be locked from inside the vehicle by pressing down the locking knobs.

The window winders are of the cable and chain type. The movement of the window winding handle is transmitted to the window itself by a cable and chain which are joined together forming an endless "drive". This is mounted on two pulleys and a sprocket. The lower pulley is provided with a spring device for tensioning.

The luggage compartment lid is built up of an outer and inner plate. The catch for the locking device is fitted on the lower edge of the luggage compartment lid. The hinges are fitted at the upper edge of the lid. The hinges are bolted to the plate under the rear window through a reinforcing plate. The

luggage compartment lid is counter-balanced with torsion rods and can be set in any position when opening. On chassis up to number 20999, the locking device is placed on the body below the lid, and on vehicles with effect from chassis number 21000, the locking device is fitted on the lid.

Interior fittings and upholstery

FRONT SEATS, LATE PRODUCTION

The front seats are built up on a tubular frame. The padding consists of foam plastic which is covered by fabric-backed vinyl. The seat can be adjusted longitudinally by releasing the catch (3, Fig. 5), and sliding the seat. The seat can be adjusted vertically at the attachment (4) which is provided with holes at different heights. The seat can be tilted to the desired position by means of the adjusting device (5). The backrest inclination is variably adjustable by means of the handwheel (2) which operates an eccentric. The seat is provided with an adjustable lumbar support (see Fig. 7), the tension of which

is adjusted with a screw (1, Fig. 5 and 3, Fig. 7) on each side of the backrest. The seat cushions are attached to the seat frame by means of press-fasteners.

REAR SEAT

The rear seat and backrest are built up in principle in the same way as the front seats, although in this case the seat frame consists of a wooden frame.

DOOR UPHOLSTERY

The door upholstery consists of wood-fibre sheeting lined with non-woven padding and covered with upholstery material. It is secured to the door by means of clips. The front armrest is made of moulded plastic and is screwed to the inner plate of the door.

HEADLINING

The headlining consists of plastic material stretched on roof ribs and secured in retainers fitted on the upper limit of the body sides.

COVERING FOR BULKHEAD AND FLOOR

The sides of the bulkhead are lined with millboard which is attached with clips. The bulkhead is covered with plastic-lined felt matting. The floor is covered with rubber mats.



Bild 5. Front seat (4-door)

1. Adjustment of lumbar support
2. Adjustment of backrest inclination
3. Longitudinal adjustment
4. Adjustment of seat height
5. Adjustment of seat inclination

Bumpers

The bumpers are composed of three parts and the upper joints are provided with overrides. The bumpers are fitted on four support bars, of which the front ones are attached to the front side members and the rear ones to the rear side members.

P 120, 2-DOOR

Body frame

The body frame is largely similar to that of the 4-door model. However, the side part is altered so that there is no longer an intermediate pillar and the rear mudguard (3, Fig. 6) is extended. The side section consists of front and rear door pillars (7 and 4), intermediate and outer cantrails (6 and 5), roof former (1), windscreen pillar (8), rear wheel arch (2) and rear mudguard (3).

Bonnet

See the 4-door model.

Doors and openings

See the 4-door model.

Interior fittings and upholstery

FRONT SEATS

The front seats on the 2-door vehicle can be hinged forwards in order to facilitate entry to the rear seats. They are provided with catches (4) in order to prevent tilting forwards (see Fig. 7).

OTHER INTERIOR FITTINGS

Concerning other fittings and the bumpers, see the 4-door model.

P 120 STATION WAGON

Body frame

The front end is the same as that on the 2-door and 4-door models. The floor section (Fig. 8) consists of the front (11), intermediate (3) and rear (4) floor plates, tunnel, inner cantrail (1), side members (6), front (10), intermediate (8) and rear (5) cross-members.

The front and intermediate floor plates are welded together at the rear seat support. The tunnel is spot-welded to the front floor plate (11). Two rear side members (6) are welded to the lower side of the intermediate (3) and rear (4) floor plates, one on each side, and between these a number of cross-members. One of the cross-members (8) is provided with an attachment (9) for the rear axle tie rod. Both the rear side members are provided with attachments for the rear axle support arms. The spare wheel well (7), which is provided with a lid in the floor, is welded on the lower side of the rear floor plate. There is a flanged hole in this for the fuel tank.

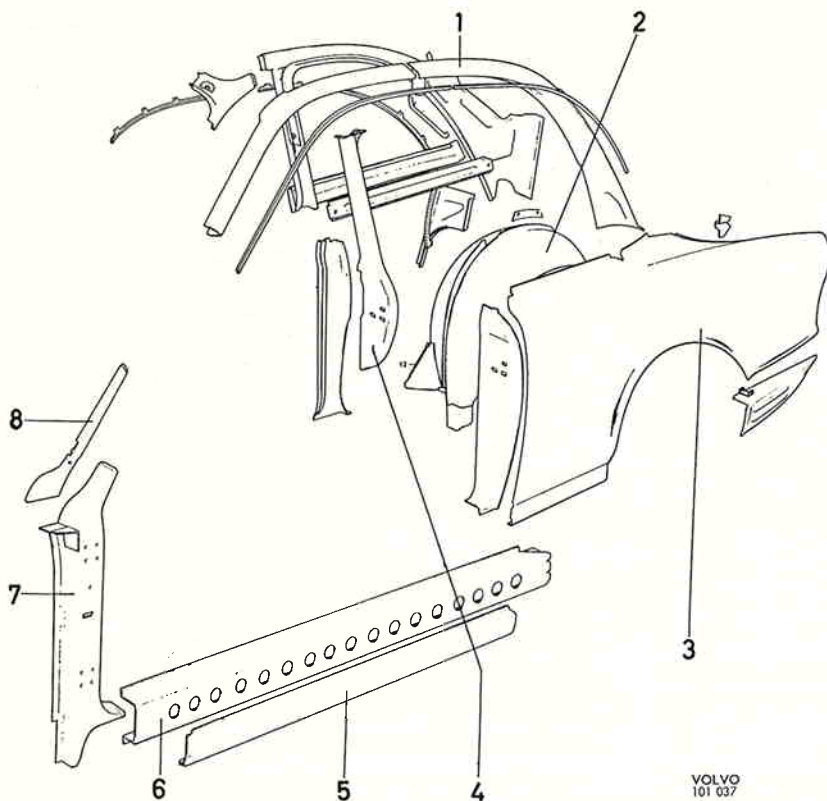

Fig. 6. Side section (2-door)

- 1. Roof former
- 2. Rear wheel arch
- 3. Rear mudguard
- 4. Rear pillar
- 5. Outer cantrail
- 6. Intermediate cantrail
- 7. Front pillar
- 8. Windscreen pillar

VOLVO
101 037

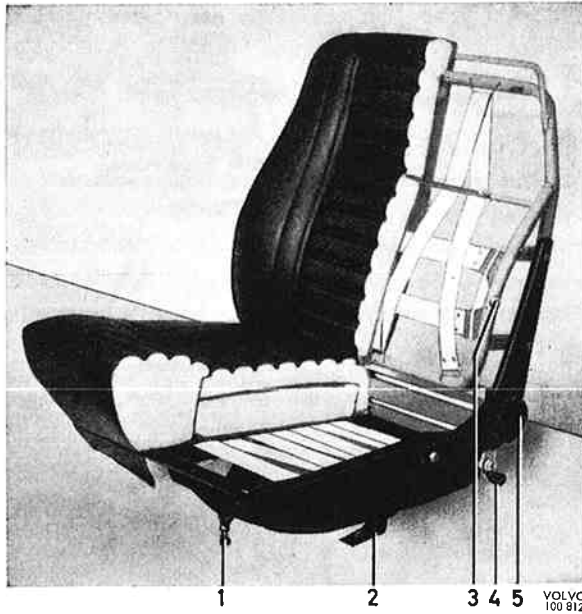

Fig. 7. Front seat (2-door)

1. Adjustment of seat inclination
2. Adjustment of seat height
3. Adjustment of lumbar support
4. Longitudinal adjustment of seat
5. Adjustment of backrest inclination

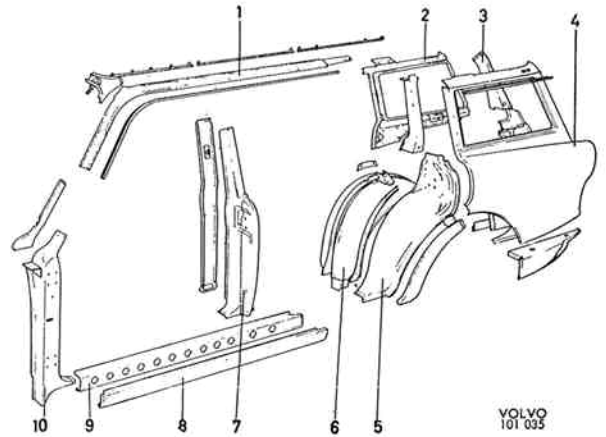

Fig. 9. Side section, Station Wagon

- | | |
|--------------------------------|------------------------------|
| 1. Roof former | 6. Rear wheel arch |
| 2. Inner frame for side window | 7. Front intermediate pillar |
| 3. Upper rear pillar | 8. Outer cantrail |
| 4. Rear mudguard | 9. Intermediate cantrail |
| 5. Rear intermediate pillar | 10. Front pillar |

The scuttle section is similar to that on the 2- and 4-door models.

The side section (Fig. 9) consists of the front pillar (10), intermediate pillar (7), rear section, intermediate (9) and outer (8) cantrails, inner and outer

roof formers (1) and windscreen pillar. The rear section is composed of the rear wheel arch (6), rear mudguard (4), inner frame (2) for rear side window and upper (3) and lower rear pillar. The upper part of the rear mudguard is extended upwards and forms the outer frame for the rear side window.

Fig. 8. Floor section, Station Wagon

1. Inner cantrail
2. Rear seat support
3. Intermediate floor plate
4. Rear floor plate
5. Cross-member
6. Side member
7. Spare wheel well
8. Cross-member
9. Attachment for rear axle support arms
10. Cross-member
11. Front floor plate

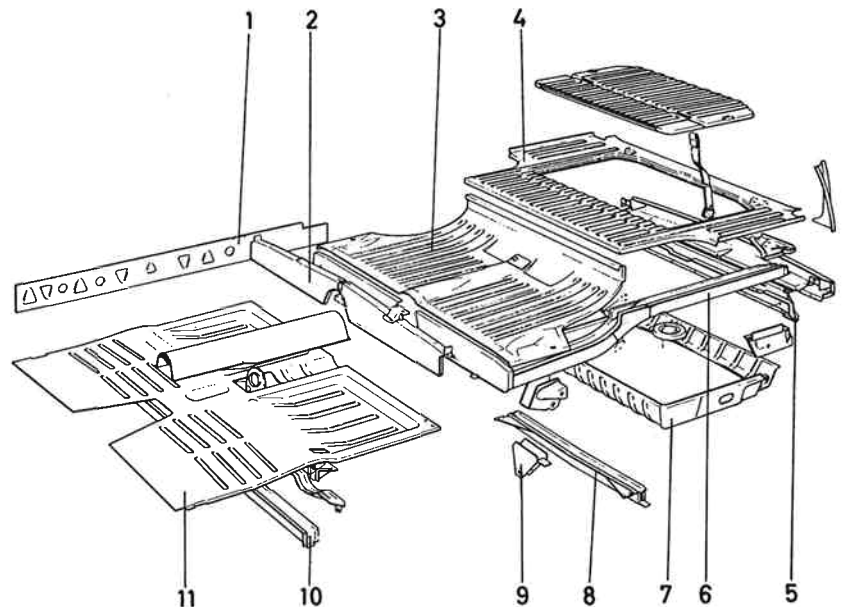

VOLVO 101 034

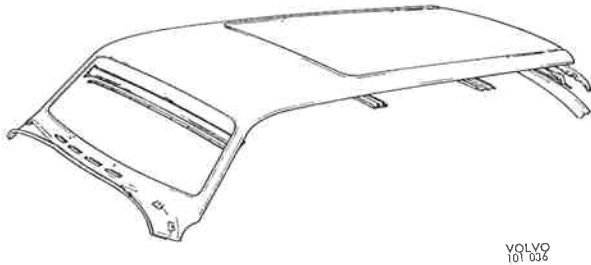

Fig. 10. Roof section, Station Wagon

The roof section (Fig. 10) consists of the roof plate, windscreen member, two roof arches and rear member.

Doors and openings

The doors on the Station Wagon are similar to those on the 4-door model. The tailgate consists of an upper and lower part. The hinges of the upper tailgate are attached to the rear edge of the roof section and those of the lower tailgate are bolted in the rear cross-member. The inside of the lower tailgate is provided with a cover plate and mat which are attached by means of screws. Both tailgate sections are locked by means of a common lock which is bolted on to the lower tailgate. Each of the tailgate sections is provided with a support for holding it in the open position. Opening of the upper tailgate is facilitated by means of a gas spring, i.e. a piston which runs in an enclosed gas-filled cylinder. There are four different opening positions.

Interior fittings and upholstery

FRONT SEATS

See the corresponding section for the 4-door model.

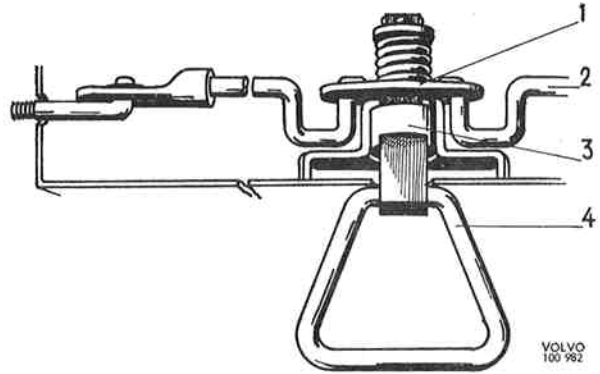

Fig. 11. Catch device for rear seat, Station Wagon

- | | |
|--------------|-----------------|
| 1. Eccentric | 3. Catch sleeve |
| 2. Pull rods | 4. Handle |

REAR SEAT

The rear seat is built up of springs on a frame and has foam plastic padding which is covered with vinyl. The seat cushion is provided with two hinges at the lower front edge and can if necessary be tipped up against the front seats. It is covered with a mat underneath and forms the front limit of the loading space when in the tipped-up position.

The backrest consists of a back plate fitted with rubber bands. The padding consists of foam plastic and the upholstery of fabric-backed vinyl. The rear side of the back plate is provided with a mat and when folded down forms an extension of the floor in the loading space. The backrest is locked in the normal position by a spring-loaded catch device, see Fig. 11, the handle (4) of which operates the latches through an eccentric (1) and pull rods (2). The lower corners of the backrest rest partly on a fixed catch and partly (on the left-hand side) on a sprung catch.

Bumpers

The bumpers are the same as on the 4-door model except that the rear overrides serve as footsteps, the upper sides of which are rubber-covered.

REPAIR INSTRUCTIONS

FRONT END

Front mudguards

The front mudguard is removed by taking out the following screws: the screw between the mudguard and stay at the lower side member, the screw between the mudguard and body side behind the above-mentioned stay, the screws in the front side section and the screws in the upper side member. In addition, the headlamp with leads must be removed. Concerning removing the headlamp, see Part 3. Fitting is done in the reverse order.

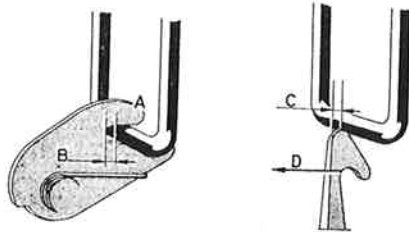

VOLVO
26802

C=2—3 mm (0.08—0.12") B=max. 3 mm (0.12") D=0.1 kg (0.22 lb.)

Fig. 12. Bonnet lock, early production

Front section

The front section is attached to the front mudguards, wheel arch plates and the upper and lower cross-members.

When removing, take out the headlamps, the screws between the front section and splash guard under the headlamp, the screws in the upper and lower cross-members and the screws in the wheel arch plates.

Bonnet and bonnet lock

The bonnet is attached by means of screws in each hinge. The bonnet is removed by taking out the screws between the hinges and bonnet. The hinges are attached to the body with four screws each. All the holes in the hinges are oval in order to permit the bonnet to be adjusted.

There are two types of bonnet lock. The early production lock (up to chassis number about 10 000) is illustrated in Fig. 12. The bonnet lock is adjusted as follows.

When the bonnet is locked the U-shaped catch should lie right inside the lock catch groove and the measurement B, Fig. 12 must not exceed 3 mm (0.12"). Any adjustment should be made on the catch itself. It should be adjusted vertically so that the gap between the bonnet and the front section

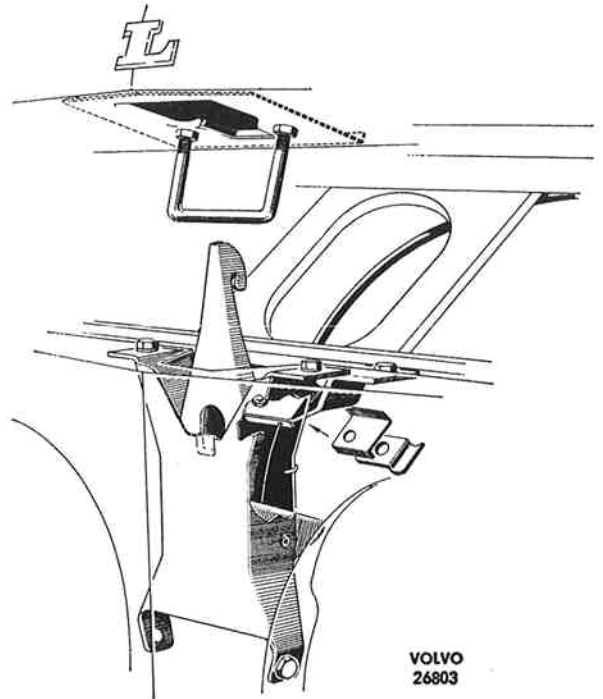

VOLVO
26803

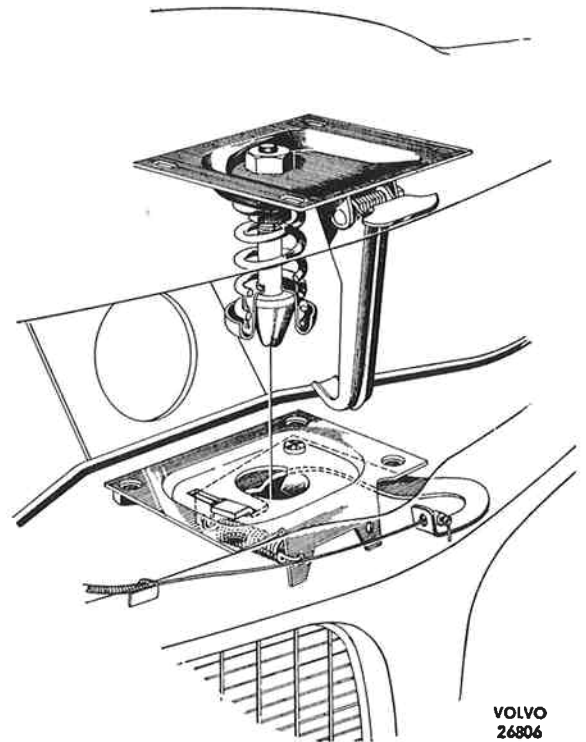

VOLVO
26806

Fig. 13. Bonnet lock, late production
of the body is 4.5 ± 1 mm (0.18 ± 0.04 "). The tension of the safety catch spring should be at least 0.1 kg (0.22 lb.) measured at D, Fig. 12, in order to move it from its rest position.

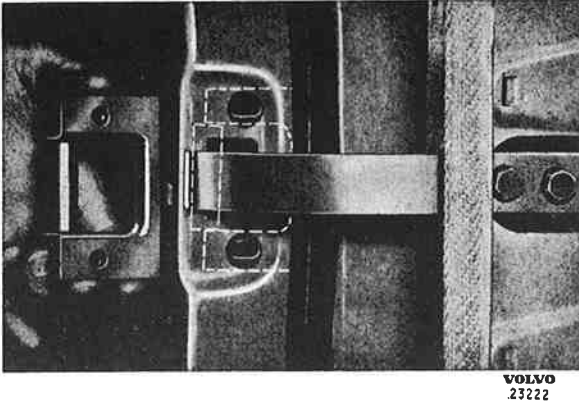

Fig. 14. Door check

When the bonnet is closed, the U-shaped catch should meet the safety catch as close to the top as possible, but not so high as to cause the hook to be pushed forwards, measurement C, Fig. 12. A small adjustment of 1—2 mm (0.04—0.08") can be made by bending the safety catch. If a larger adjustment is found to be necessary, this means that the whole locking device has been displaced. In this case the complete bonnet lock must be reset. The late production lock, with effect from chassis number about 10 000, is illustrated in Fig. 13. The lock can be adjusted laterally and longitudinally since the holes in the front section are larger than the diameter of the attaching screws. The length of the latch is adjustable by means of nuts. The latch and spring are lubricated with grease.

DOORS

Removing front door

1. Remove the door check, see Fig. 14. The attaching bolts for this are accessible after the side insulation material on the body has been removed. The door check can also be removed by unscrewing the guide roller and pulling it off. In order to get at the guide roller, the door upholstery must be removed, see under "Removing the door handle and upholstery".
2. Unscrew the four countersunk screws which hold the door to the upper and lower hinges. The door sealing strip must be moved in order to get at the hinge screws. This is done by releasing the two plates over the hinges to which the strip is glued and carefully pulling to one side, see Fig. 15. When doing this, make sure that the rubber strip does not come away from the plate or door.

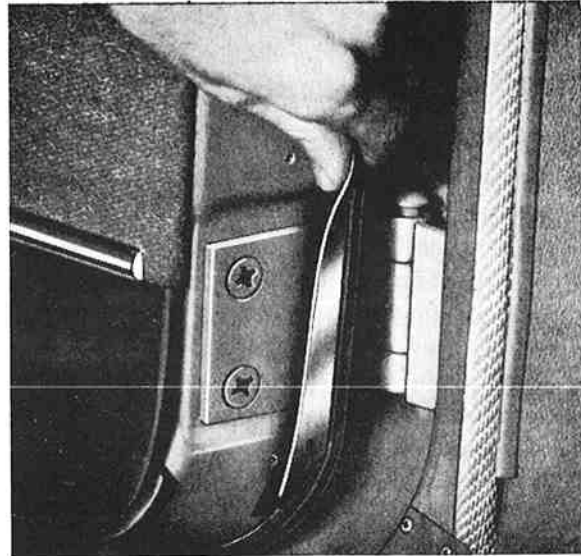

Fig. 15. Plate over hinge

Fitting the door is done in the reverse order to removing. Since the holes in the door are larger than the diameter of the bolt, and the nut plates are movable, the hinge attachment can be adjusted both vertically and laterally. The door is adjusted longitudinally at the hinge attachments in the body.

Removing rear door

(See also under "Removing front door")

1. Remove the door check. The attaching bolt for this is accessible after the rubber plug in the centre pillar has been removed.
2. Remove the plates over the hinges.

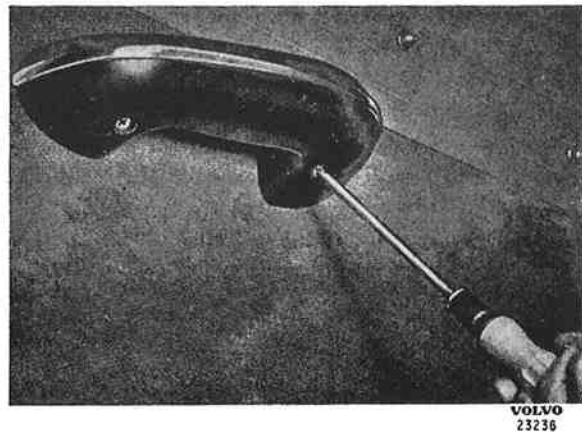

Fig. 16. Removing armrest

3. Remove the screws in the hinges and lift off the door.

The holes in the centre pillar are larger than the diameter of the bolts. When running nuts are used, this enables the door to be adjusted both vertically and laterally.

Removing door handle and upholstery

1. Remove the armrest, which is attached with two screws accessible from underneath the armrest, see Fig. 16.
2. Remove the door handle and window winding handle. These are removed by prising out the locking washer which holds them with tool SVO 2297, see Fig. 17. The window winder, locking washer and circlip are illustrated in Fig. 18.
3. Remove the upper trim moulding. This is attached to the door edges by four screws, see Fig. 19.

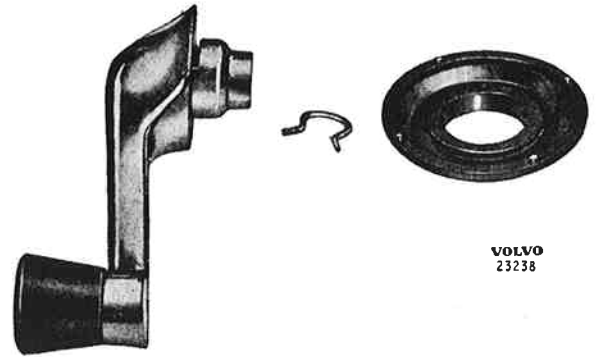

Fig. 18. Window winder with circlip

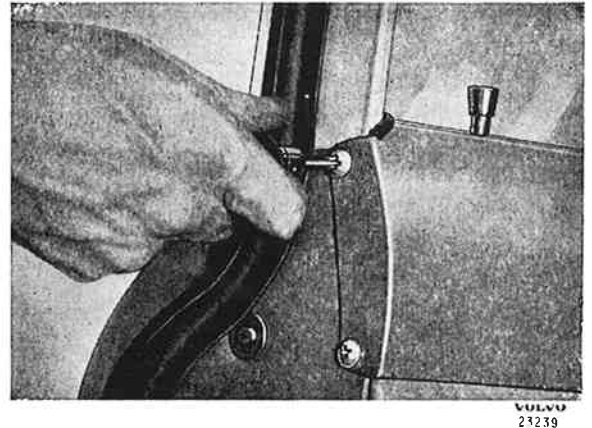

Fig. 19. Removing the upper trim moulding

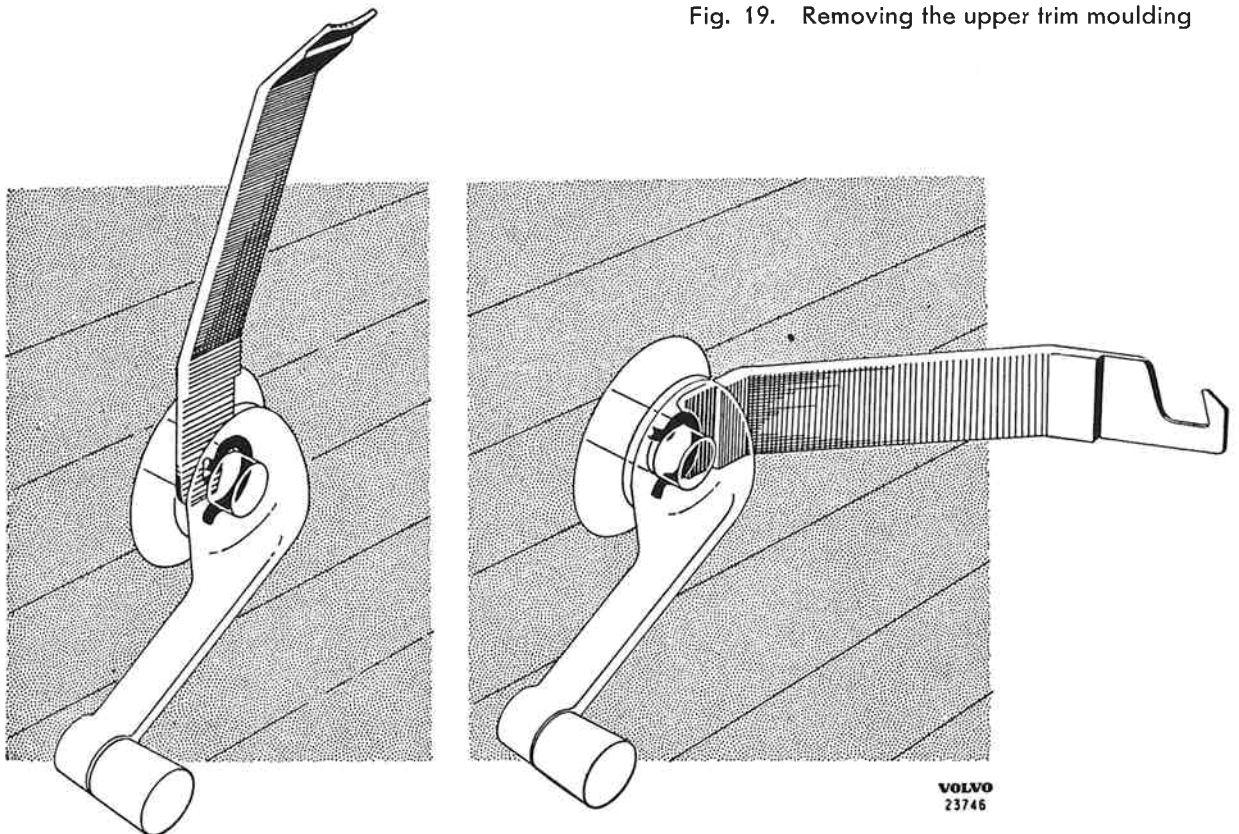
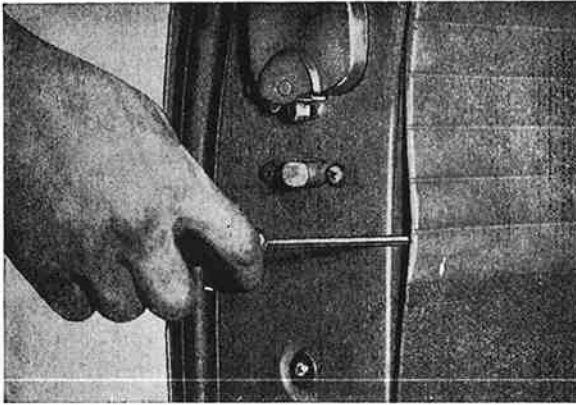
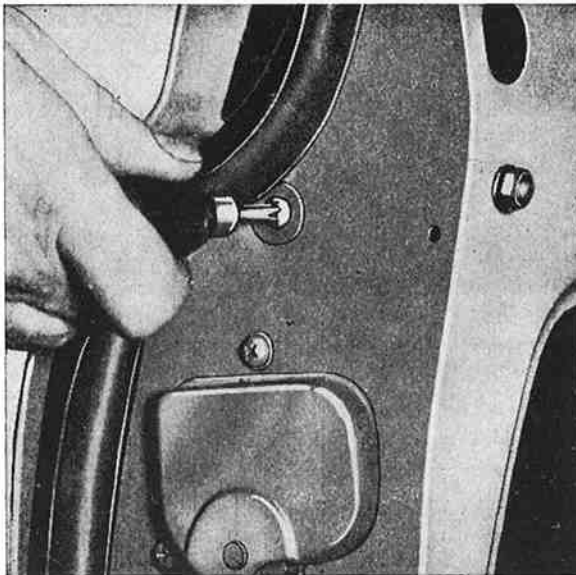

Fig. 17. Removing and fitting the window winder



VOLVO
23240

Fig. 20. Removing the door upholstery



VOLVO
23241

Fig. 21. Removing upper screw for guide rail

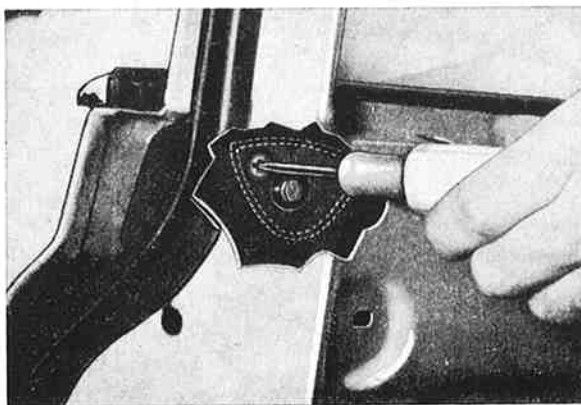

VOLVO
23256

Fig. 22. Removing the lock handle

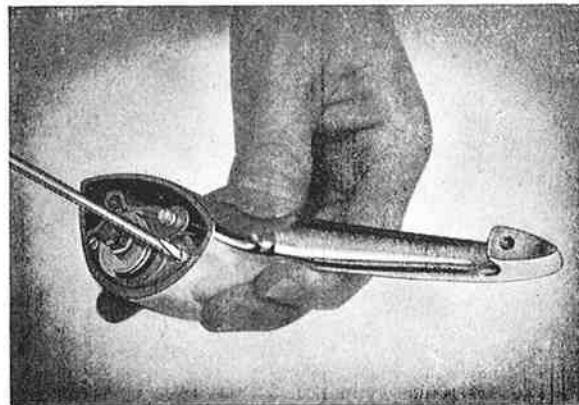

VOLVO
23242

Fig. 23. Dismantling the lock handle

4. Remove the door upholstery by carefully applying a screwdriver or similar under the padded edge and then prising outwards, when the upholstery will come away, see Fig. 20.
5. Remove the paper protectors which are fitted over the holes in the inner plate of the door.

Door locks and door handles

REMOVING DOOR LOCKS AND LOCK HANDLES

Carry out operations 1—5 under "Removing the door upholstery".

1. Unscrew the two screws which hold the guide rail for the window. The screws are accessible from the edge of the door as shown in Fig. 21. Lift out the guide rail.
2. Unscrew the three screws which hold the inner handle mechanism (remote control).
3. Lift off the link arm between the lock knob roller mechanism and disconnect the link for the outer handle from the roller mechanism.
4. Unscrew the four screws on the edge of the door which hold the toothed roller mechanism.
5. Lift off the door with remote control.
6. The door handle is removed by unscrewing the two screws which hold it, see Fig. 22. The screws are accessible from the inside of the door and are most easily removed after the window has been let down or taken out, see under "Window winder with mechanism".

DISMANTLING THE DOOR HANDLES

1. Unscrew the two screws which hold the press-button and lock plunger to the door handle, see Fig. 23.
2. Press out the locking pins as shown in Fig. 24.
3. Turn the key backwards and forwards a few times in the press-button at the same time as pulling outwards, when the lock plunger will release and can be pulled out as shown in Fig. 25.



VOLVO
23243

Fig. 24. Pressing out the locking pin

FITTING AND ADJUSTING THE LOCKS

Front door

1. Fit the lock (10, Fig. 26) with remote control (12) in the door without tightening the screws.
2. Adjust measurement A, Fig. 28 to 15 ± 0.5 mm (0.59 ± 0.02 ") by turning the lock. Tighten the lock hard. If it is not possible to obtain the correct measurement for A by turning the lock after it has been tightened up as near to A as possible, the remaining adjustment is done by bending the lever (5). Measurement A must be checked within the specified tolerances.
3. The remote control (12) with split pin (11) fitted is pushed backwards so that the lever (9) stops against the lock (10). The remote control is screwed on in this position. Remove the split pin (11).
4. Fit the lever (7) for the inner locking knob (15).



VOLVO
23244

Fig. 25. Press-button dismantled

Fig. 26. Adjusting the front door lock

1. Outer handle
2. Lock nut
3. Adjusting screw
4. Pin (for checking)
5. Lever
6. Link
7. Lever.
8. Lever
9. Lever
10. Lock
11. Split pin
12. Remote control
13. Locking spring
14. Lever
15. Locking knob

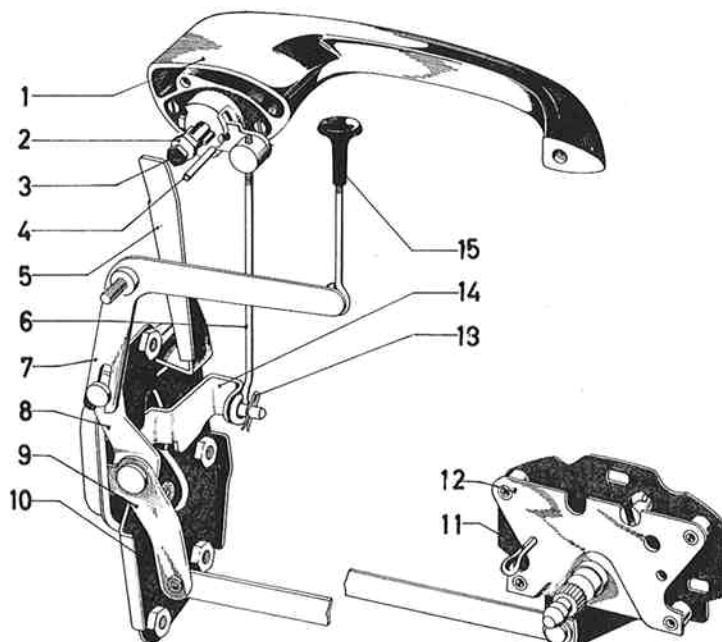

VOLVO
101 144

Rear door

1. Fit the lock (11, Fig. 27) with remote control (13) in the door without tightening the screws.
2. Adjust measurement A, Fig. 28 to 17 ± 0.5 mm (0.67 ± 0.02 ") by turning the lock. Tighten the lock hard. If it is not possible to obtain the correct measurement for A by turning the lock after it has been tightened up as near to A as possible, the remaining adjustment is done by bending the lever (5). Measurement A must be checked within the specified tolerances.
3. The remote control (13) with split pin (12) fitted is pushed backwards so that the lever (10) stops against the lock (11). The remote control is screwed on in this position. Remove the split pin (12).
4. Fit the lever (17) and connect the link (16) to the lever (7).
5. Set the lever (7) in the locked position, i.e. backwards against the lock and lever (14) in the rear catch position. Check through the control hole (12) that the lever moves fully to the catch position. In this position the lever (14) is locked to the link (16) with screws at the clips (15). Check that the link (16) does not rub against the inner plate of the door. On the other hand it must not be bent out so much that it rubs against the screws of the inner trim moulding.

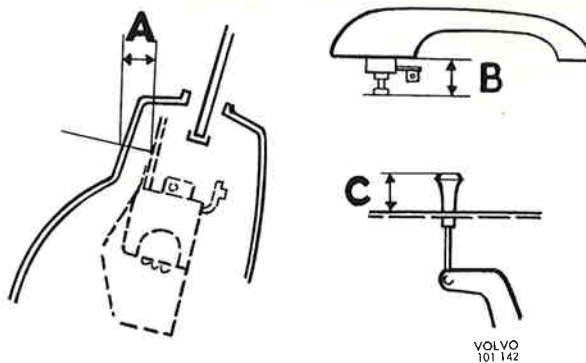

Fig. 28. Adjusting measurements for lock

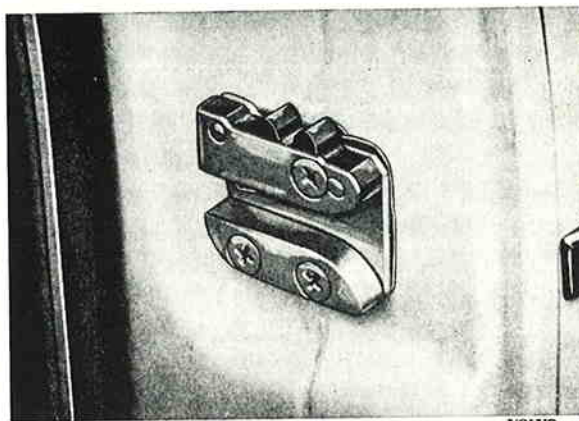
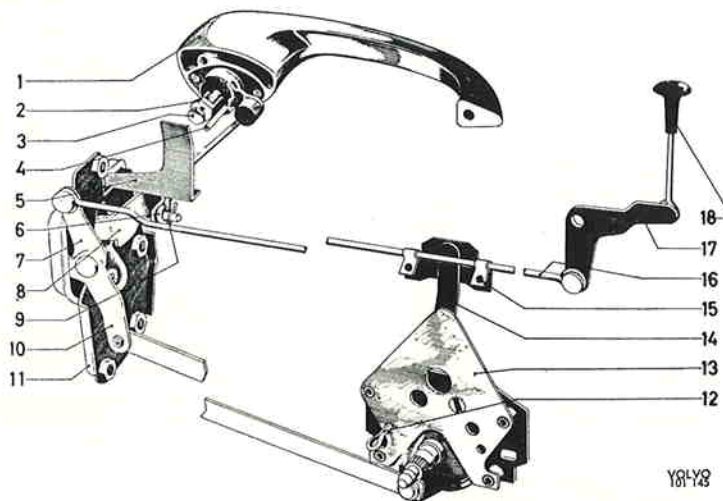

Fig. 29. Striker block

Fig. 27. Adjusting the rear door lock

1. Outer handle
2. Locknut
3. Adjusting screw
4. Pin (for checking)
5. Lever
6. Link
7. Lever
8. Lever
9. Locking spring
10. Lever
11. Lock
12. Split pin
13. Remote control
14. Lever
15. Clip
16. Link
17. Lever
18. Locking knob



FITTING AND ADJUSTING THE OUTER HANDLES

Front door, early production

1. Check that measurement B, Fig. 28 = 15 ± 1 mm (0.59 ± 0.04 "). Adjust if necessary. Tighten the locknut (2) on the screw (3), Fig. 26.
2. Fit the outer handle (1) with link (6) fitted on.
3. Connect the link (6) to the lever (14). Adjustment is done by selecting one of the three holes so that the recess and hole in the outer handle coincide. This is done by inserting a pin (4) into the hole in the outer handle as shown in the figure. They should come in line when the locking knob (15) is pressed down, i.e. the lever (7) is pressed down and the lever (8) moved backwards against the lock.

Late production

1. Check that the measurement B, Fig. 28 = 15 ± 1 mm (0.59 ± 0.04 "). Adjust if necessary. Tighten the locknut (2) on the screw (3), Fig. 26.
2. Fit the outer handle (1) with link (6) fitted on.
3. Connect the link (6) with the lever (14). The lever in the handle is set in such a position that a pin (4) (3 mm = 0.12") can be inserted in the hole in the handle. Adjusting is done by screwing the link up or down so that the loop of the link (6) comes in line with the lever (14) on the lock.

Rear door

Late production

1. Check that the measurement B, Fig. 28 = 15 ± 1 mm (0.59 ± 0.04 "). Adjust if necessary. Tighten the locknut (2) on the screw (3), Fig. 27.
2. Fit the outer handle (1) with link (6) fitted on.
3. Connect the link (6) with the lever (8). The lever in the handle is set in such a position that a pin (4) (3 mm = 0.12") can be inserted in the hole in the handle. Adjusting is done by screwing the link up or down so that the loop of the link (6) comes in line with the lever (8) on the lock.

Inner locking knob

With the locking knob in the pressed-down position, measurement C, Fig. 28 should be 12 ± 1 mm (0.47 ± 0.04 ") for both the front and rear door.

STRIKER BLOCK

The striker block (Fig. 29) is made of steel and fitted with a floating nut plate. The block is adjustable since the holes in the body have a larger diameter than that of the attaching screws. The vertical position of the striker block is checked by closing the door with the press-button of the outer handle pressed in, when the dowel pin should slide correctly into the striker block. N.B. This should be done immediately after the striker block has been fitted.

Ventilation windows

REMOVING AND FITTING

The ventilation window is built in with one of the guide rails for the winding window. A suitable procedure for removing the ventilation window with sealing strips is as follows:

1. Carry out operations 1—5 under "Removing the door upholstery".
2. Unscrew the five screws which hold the window to the door and door arch, see Figs. 30 and 31.

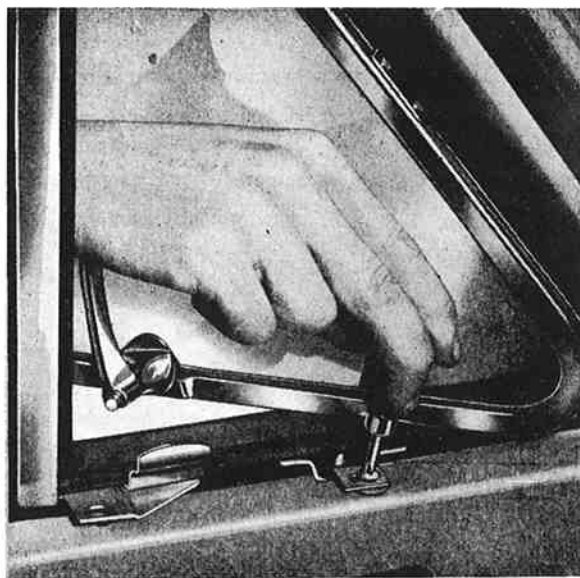

VOLVO
101 340

Fig. 30. Attaching screw for ventilation window

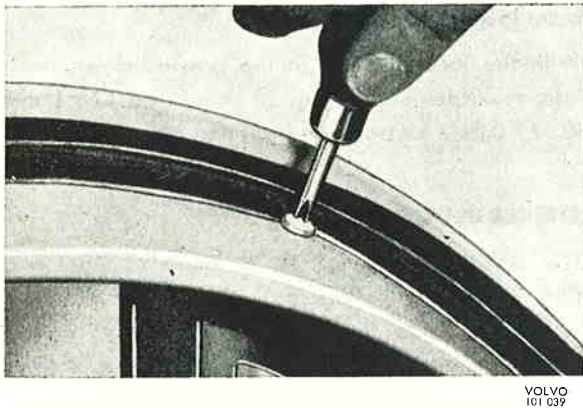

Fig. 31. Upper attaching screw for ventilation window

3. Unscrew the screws which hold the guide rail for the winding window, see Fig. 32. This only applies to the extended guide rail on the front doors.
4. Remove the upper guide strip with a screwdriver as shown in Fig. 33.
5. Lift up the window as shown in Fig. 34.

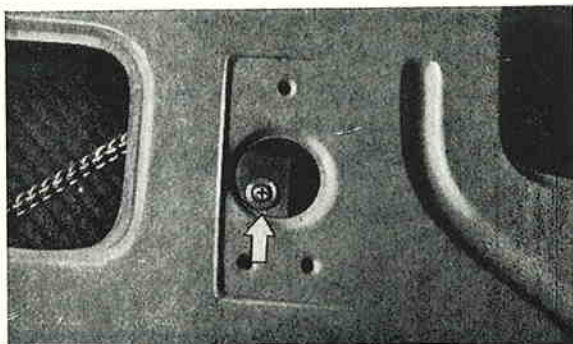

Fig. 32. Attaching screw for winding window guide rail

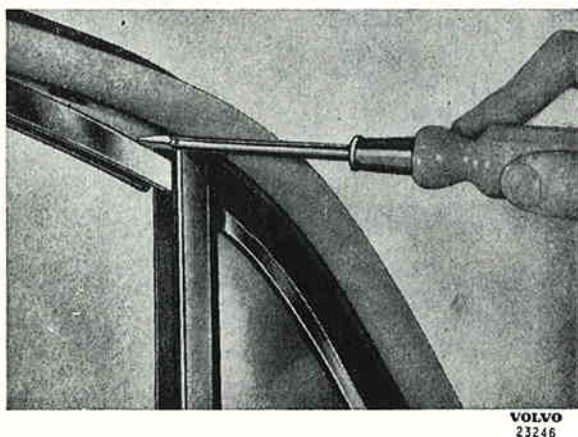

Fig. 33. Removing upper guide strip

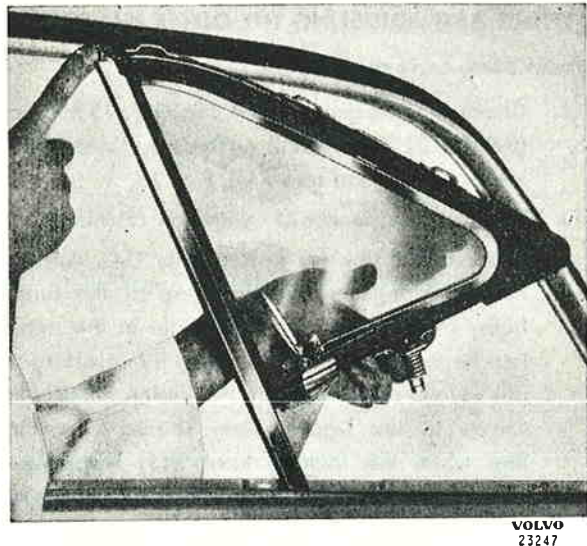

Fig. 34. Lifting out the ventilation window

Window winder with mechanism

REMOVING AND FITTING

Carry out operations 1—5 under "Removing the door upholstery".

Carry out operations 1—5 under "Ventilation windows, removing and fitting".

1. Remove the clip which holds the carrier on the winding cable to the rail under the window and lift it up as shown in Fig. 35. On the rear doors there is no carrier and the clip fits directly on the winding chain.
2. Release the cable tensioning device by slackening the nut for the catch screw on the lower pulley. Lift off the cable and chain.
3. If necessary remove the upper pulley, lower pulley with tensioning device and winding sprocket itself. The winding sprocket is removed by unscrewing the four screws, Fig. 36, after which the sprocket with shaft is lifted out. Before fitting the winding window, make sure that the guide strips and seals are in good condition. Worn or damaged parts must be replaced.

The cable for the winding mechanism should be tensioned well but not too hard. Lubricate the cable and chain with grease and the pulley and winding sprocket with oil.

After fitting, check that the window runs easily in the guide rails.

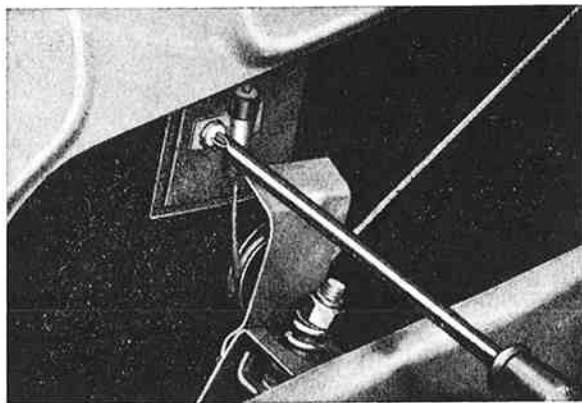
VOLVO
23248

, Fig. 35. Removing clip for carrier

VOLVO
23249

Fig. 36. Removing sprocket

Sealing strips

A. BONDED STRIPS

The following procedure is recommended when fitting new rubber strips:

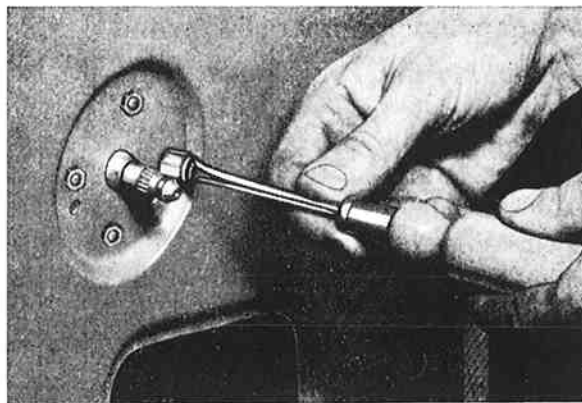
1. Remove the old strips.
2. All traces of old adhesive should be carefully removed from the metal surfaces with petrol or similar. It is most important to carry this out carefully since no residue from old adhesive must be left on the metal, but at the same time care must be taken to make sure that the paintwork is not damaged by the solvent used. (Requirements: clean rags, wooden putty knife).
3. The new rubber strips should be thoroughly cleaned with petrol, methylated spirit or similar. (Requirements: clean rags, fibre brush).
4. After they have dried, the rubber strips should be coated with Dekalin TH or equivalent and then allowed to dry to a non-tacky state, which usually takes about 15 minutes. (Requirements: thick hair brush).
5. The metal surfaces to which the rubber strips are to be attached are then coated with Dekalin TH. (Requirements: thick hair brush).
6. The treated and non-tacky rubber strips are then pressed on to the newly-coated adhesive on the metal.
7. The rubber strips should be pressed firmly against the metal surfaces so that there is no air trapped in the joints.

N.B. Wait for at least 15 minutes after the strips have been applied before closing the door.

B. STRIPS ATTACHED WITH FASTENING RAIL

On late production vehicles the sealing strip is attached by means of a fastening rail which is spot-welded to the door.

The sealing strip is removed by pulling it outwards, when the ridge of the strip releases from the rail. When fitting the sealing strip, one of the ridges is placed in position in the rail, after which the other ridge is pressed down into the rail with the help of a screwdriver. This is moved along the rail as shown in Fig. 37.

VOLVO
26831

Fig. 37. Fitting sealing strip for door

Luggage compartment lid, 2- and 4-door models

The luggage compartment lid is mounted on two hinges, both of which are attached by means of three screws to the inner plate of the lid and with two screws to the plate under the rear window.

The holes in the part of the hinges fitted in the lid are oval so as to permit longitudinal adjustment. In order to obtain lateral adjustment the holes in the body under the rear window are made larger than the diameter of the screws. These screws are accessible after the insulating material round the edge of the rear window has been removed.

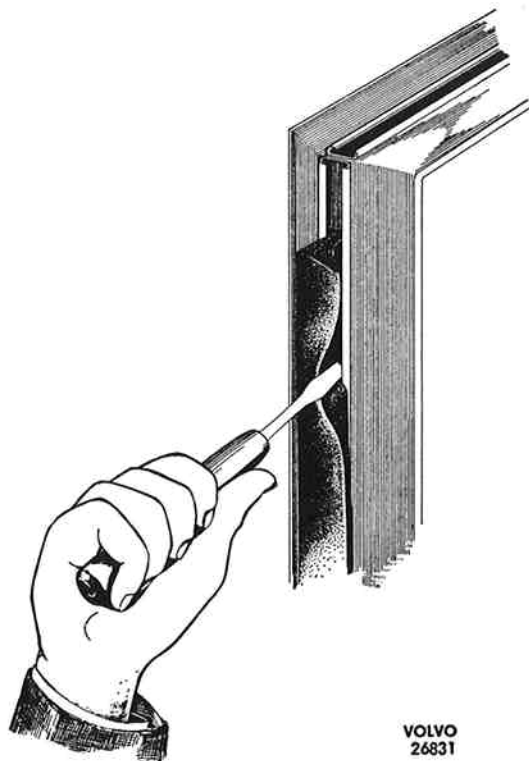
When removing the luggage compartment lid, tension must first be removed from the torsion rods which support the lid.

Apply tool SVO 2572 as shown in Fig. 38 and prise down the loop on the torsion rod until the catch releases. Move aside the catch and let the torsion rod move back. Remove the torsion rod attachment in the body. The other end of the tool is used as shown in Fig. 39. Prise upwards with the tool so that the bent part of the torsion rod slides out of the groove. Hold the tool in this position and grasp the middle of the torsion rod with one hand and pull it outwards as shown in Fig. 39 so that it releases from the bracket when the tool is moved back and the torsion rod is relieved of tension.

The locking device on vehicles with chassis numbers lower than 21000 is attached with two screws and a circlip on the body under the luggage compartment lid. The locking device is released by pressing in the lockable press button. The locking clamp on the lower edge of the luggage compartment lid is adjustable in order to permit variation of the tightness with which the lid can be locked.

When removing the lock, the two screws at the edge of the luggage compartment opening in the body are removed as well as the circlip round the lock press-button, see Fig. 40. When fitting, the circlip is first fitted and then the screws. Make sure that the rubber washer round the lock button seals properly.

The locking device on vehicles with effect from chassis 21000 is attached to the luggage compartment lid by means of screws. The catch fitting is attached to the body with two screws. The lock is adjusted by screwing the link (5, Fig. 41) up or down. The lock cylinder (2) is attached to the handle with a nut. The catch fitting is provided with oval holes in order to permit adjustment.

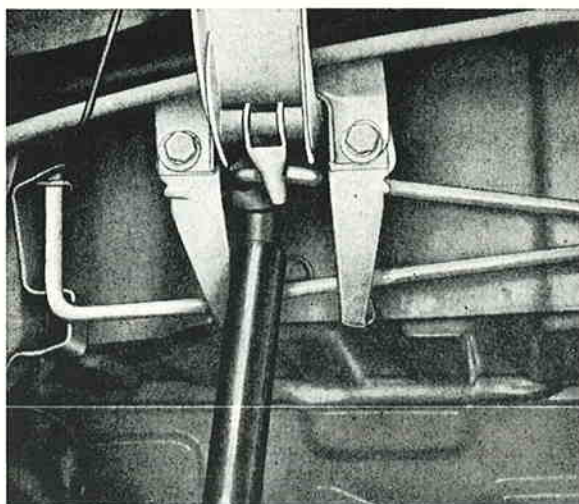

VOLVO
101 060

Fig. 38. Releasing the torsion rod

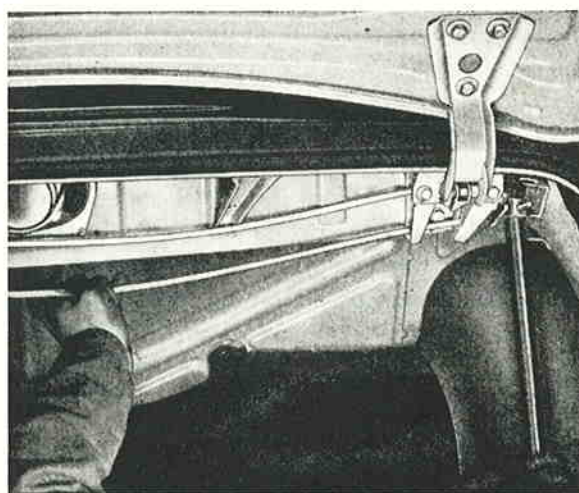

VOLVO
101 061

Fig. 39. Removing the torsion rod

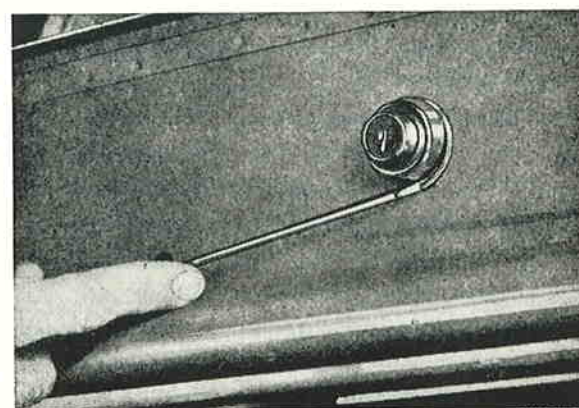

VOLVO
23235

Fig. 40. Removing circlip for lock press-button

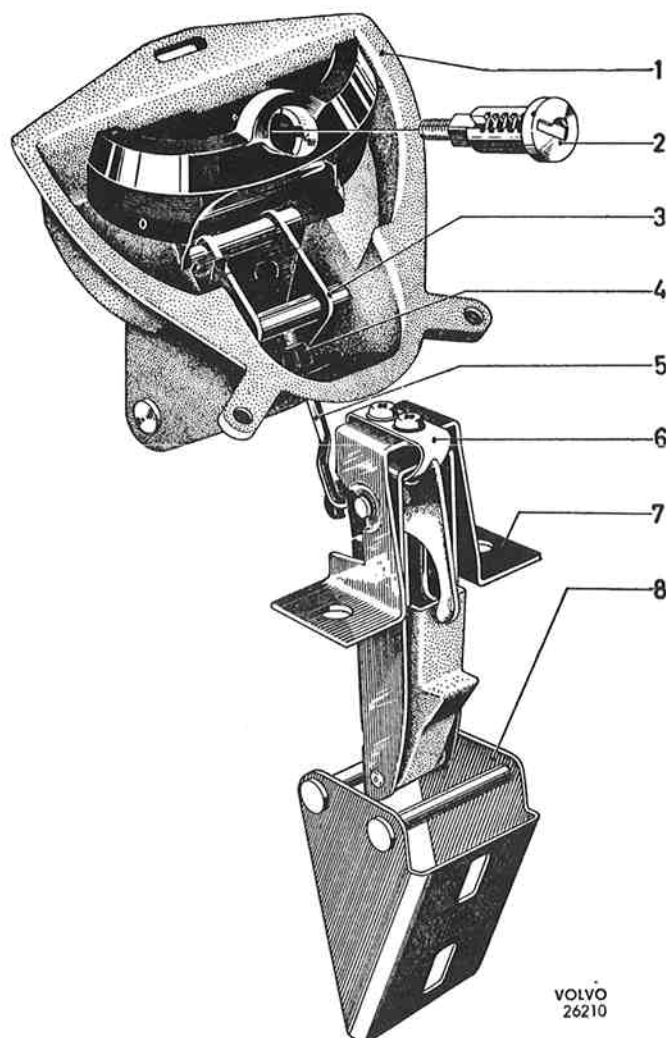

Fig. 41. Lock for luggage compartment lid, late production

- | | |
|-------------------|------------------|
| 1. Handle | 5. Link |
| 2. Lock cylinder | 6. Guide spring |
| 3. Lock mechanism | 7. Lock |
| 4. Rubber bush | 8. Catch fitting |

TAILGATE, STATION WAGON

Upper tailgate

REMOVING THE UPPER TAILGATE

1. Unscrew the upper support from the tailgate.
2. Late production. Unscrew the gas spring from the tailgate.
3. Carefully pull down the headlining at the rear edge beginning in the middle and continuing outwards towards the corners. The teazel strip at the corners is bent out slightly with a putty knife. The fabric is then carefully lifted off the projection of the teazel strip with the help of the putty knife. Remove the headlining fabric up to the rear stretcher as shown in Fig. 42.

4. Unscrew the nuts for the hinges and remove the latter.

FITTING THE UPPER TAILGATE

1. Place the hinges with packings in position. Screw on the nuts, adjust the position of the tailgate and tighten the nuts.
2. Fold the plastic strip for the headlining as shown in Fig. 43 and press it up into position with the help of the putty knife. Attach the fabric at the corners as shown in Fig. 44.
3. Adjust the teazel strip against the body with a hammer and piece of rubber as shown in Fig. 45.

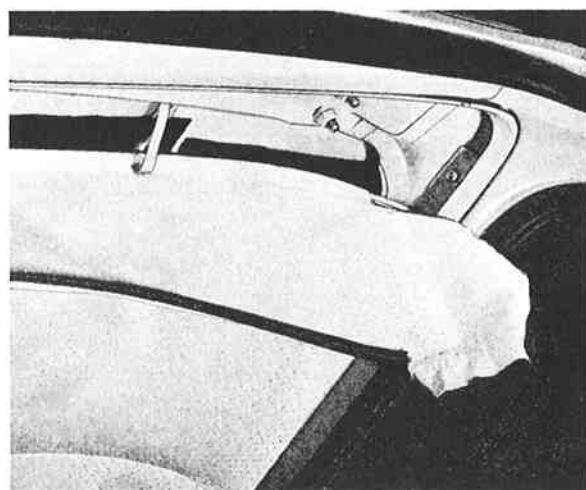

Fig. 42. Headlining fabric removed to expose upper tailgate hinge nuts

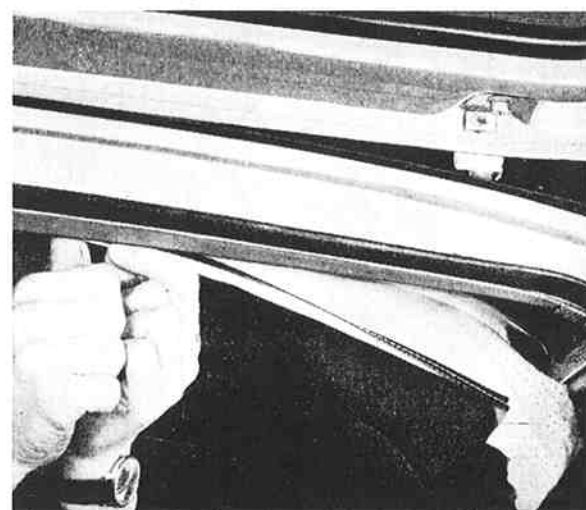
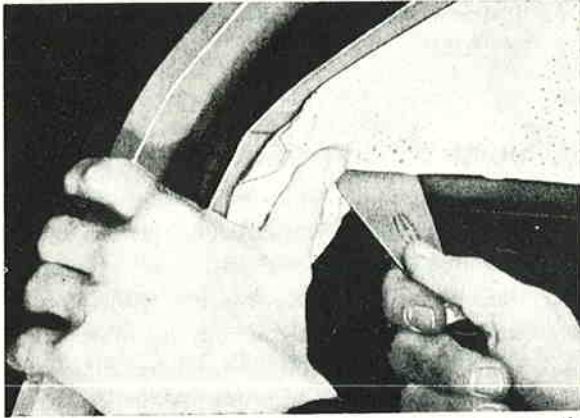
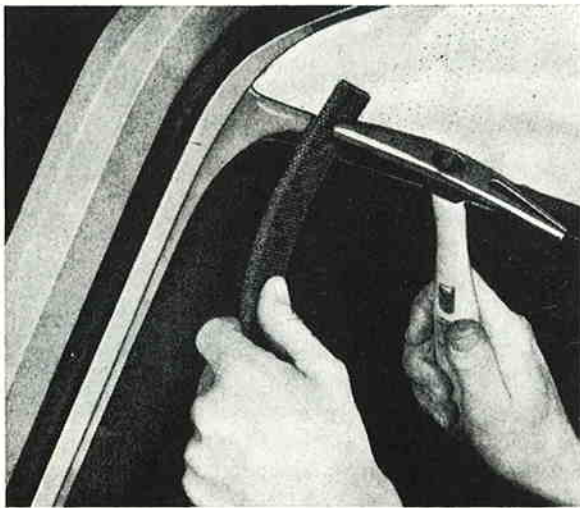

Fig. 43. Folding and fitting rear plastic strip



VOLVO
100 953

Fig. 44. Fitting headlining fabric in corner



VOLVO
100 952

Fig. 45. Adjusting teazel strip

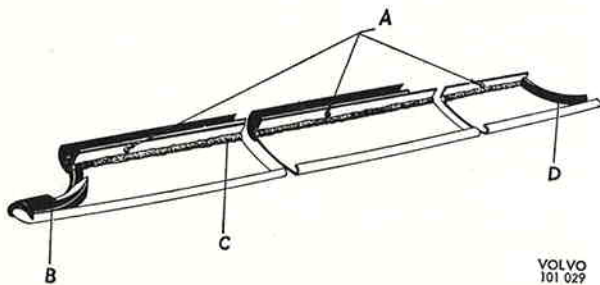

VOLVO
101 029

Fig. 46. Window moulding

- A. Indentations
- B. Rubber strip
- C. Sealing compound
- D. Rubber strip

TRIM MOULDINGS

Waist mouldings

The waist mouldings, and the upper trim moulding for the door on the P 120 2-door model, are attached with clips. The mouldings are removed with the help of a putty knife with which they are carefully unfastened. Before fitting the mouldings, the holes should be filled with sealing compound.

Window mouldings

REMOVING

Wind down the window. Apply masking tape or similar as shown in Fig. 47 in order to protect the paintwork. From inside, place a screwdriver under the rear edge of the moulding in line with the indentations which secure it, see Figs. 46 and 48. Prise carefully upwards with the screwdriver and at the same time pull outwards and downwards with the hand so that the rear retaining spring can be hooked off with SVO 2297, see Fig. 49. Carefully pull out the moulding backwards.

FITTING

Stick the profile rubber strips at both ends of the window moulding and apply sealing compound along the inner section of the moulding, see Fig. 46. Place the retaining springs in position and apply sealing compound as shown in Fig. 50. Push the window moulding in position under the rubber strip of the ventilation window as shown in Fig. 51. Lift the inner ridge of the moulding over the metal edge of the door and press down so that the indentations, Fig. 46, locate in the holes in the sheet metal edge. Press up the retaining springs with SVO 2297, see Fig. 52.

Moulding for rear side window, Station Wagon

When fitting the clips for the moulding, one of the legs is inserted in the recess in the moulding, the clip pressed together and the other leg inserted. Apply sealing compound over the fastenings and press the moulding into position.

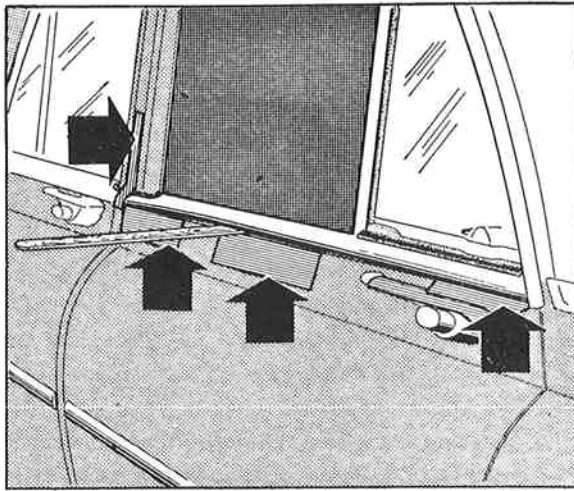

VOLVO
23741

Fig. 47. Application of masking tape

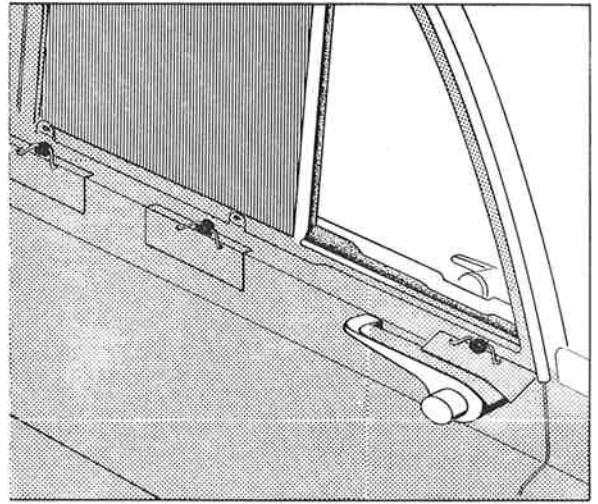

VOLVO
101 175

Fig. 50. Position of springs

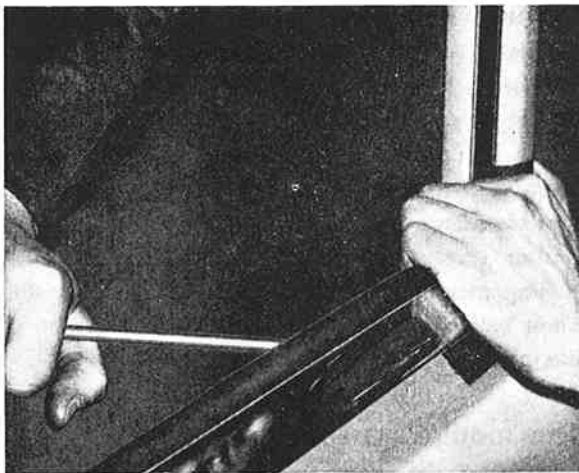

VOLVO
101 071

Fig. 48. Removing window moulding

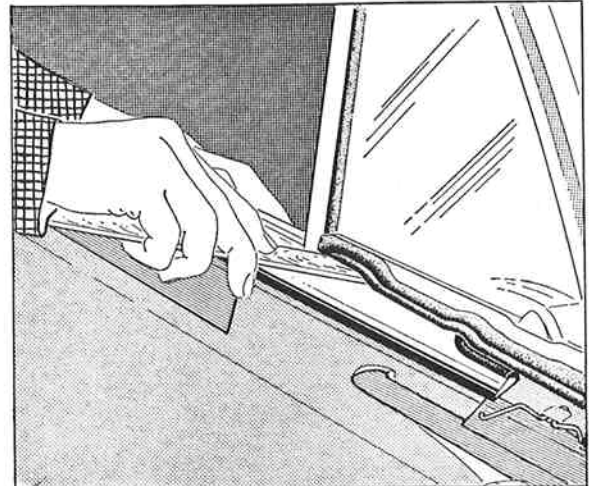

VOLVO
23744

Fig. 51. Fitting window moulding

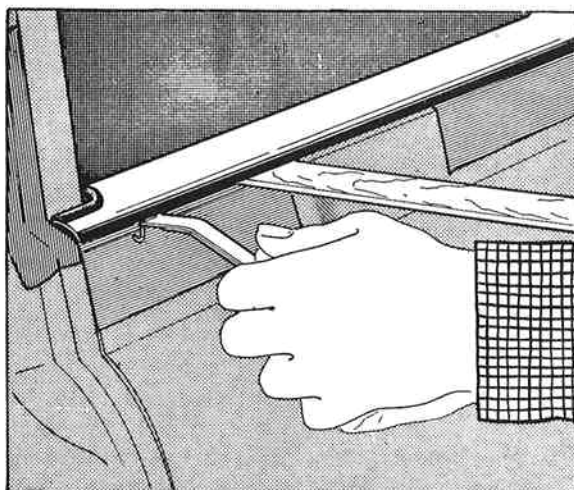

VOLVO
23742

Fig. 49. Removing spring

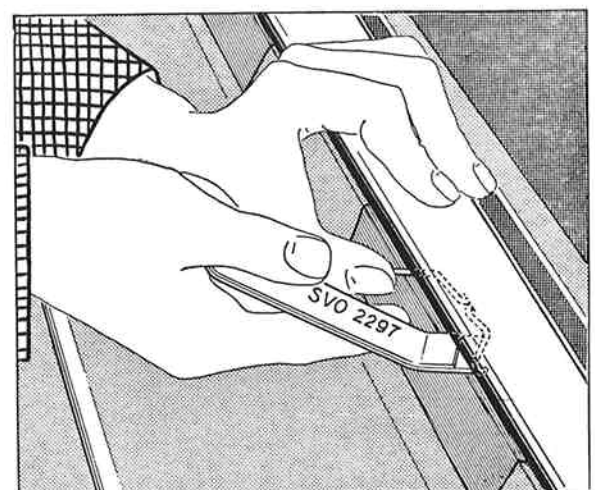

VOLVO
23745

Fig. 52. Fitting spring

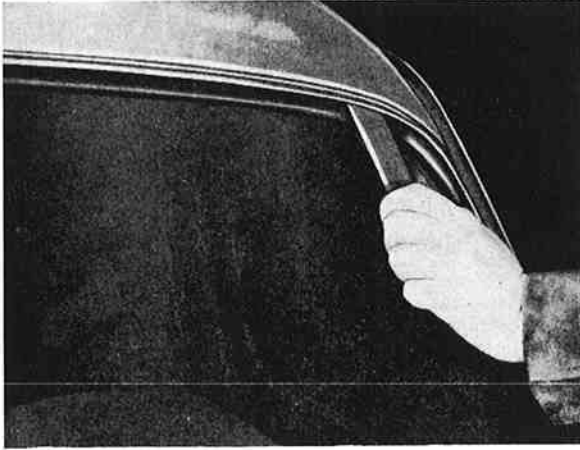

VOLVO
100 969

Fig. 53. Removing trim moulding



VOLVO
100 968

Fig. 54. Removing trim moulding from rubber strip

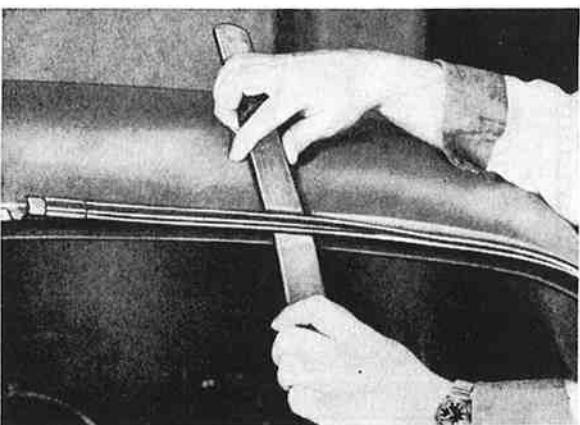

VOLVO
100 966

Fig. 55. Removing trim moulding

Trim mouldings, windscreen

REMOVING

1. Remove the trim moulding from the rubber strip by inserting a moistened nylon putty knife between the strips and moving it all round, see Fig. 53. (Do not pull off the trim moulding).
2. Push over the joining pieces to one of the halves of the moulding.
3. Remove the trim moulding by prising out the ridge of the rubber strip from the trim moulding with a moistened wooden putty knife and releasing the trim moulding in the middle with another putty knife as shown in Fig. 54. Prise off the moulding carefully while releasing the rubber strip with the other putty knife, see Fig. 55.

FITTING

Moisten a 4.0 mm (5/32") leather cord in soap solution or paraffin and place it in the groove of the rubber strip for the trim moulding. Place one half of the trim moulding in position and hold it there while pulling the leather cord out upwards over the moulding so that it is pressed against the rubber strip as shown in Fig. 56. Push on the joining pieces and repeat the procedure with the other half of the moulding. Adjust the position of the joining pieces over the joints.

Trim mouldings, rear window (2- and 4-door models)

REMOVING

1. Push the joining pieces at the lower corners backwards. Release the lower trim moulding by pressing it upwards out of the rubber strip with a wooden putty knife. Pull the trim moulding upwards carefully and follow round with the putty knife.
2. Release the side mouldings in the same way with the putty knife and remove them. Remove the angular joining pieces by pulling them downwards and turning inwards at the same time.
3. Remove the upper trim moulding in the same way as the lower one.

FITTING

1. Moisten a 4.0 mm (5/32") leather cord in soap solution or paraffin and place it in the groove of the rubber strip for the trim moulding. Start and finish at one of the upper corners.

2. Place the upper trim moulding in position and press it up against the rubber strip. Pull out the leather cord and press in the trim moulding at the same time. Fit the angular joining pieces.
3. Press on the side mouldings and push them up into the joining pieces. Fit the side mouldings in the same way as the upper trim moulding.
4. Fit the lower trim moulding in the same way as the upper one. Fit the lower joining pieces.

WINDOWS

Windscreen

REMOVING THE WINDSCREEN

1. Remove the interior rear view mirror, interior trim mouldings round the windscreen and the windscreen wiper arms. Place protective padding over the bonnet, front seats and backrests.
2. Remove the trim mouldings as described in operations 1—3, "Removing the trim mouldings".
3. Release the rubber strip both from the windscreen and sheet metal by inserting a wooden putty knife moistened in synthetic washing solution (the putty knife should be moistened now and then during the course of the work) between the rubber strip and windscreen and between the rubber strip and sheet metal respectively.
4. Start removing the rubber strip in the upper left-hand corner by prising the rubber strip over the sheet metal edge from inside and at the same time carefully pulling out the strip from outside with a pair of grips as shown in Fig. 57. Then carefully pull off the strip by hand all round as shown in Fig. 58 and remove the windscreen.

Remove all sealing compound from the sheet metal. If it has dried on, first carefully scrape off the sealing compound and then wash clean with naphtha. Check that the sheet metal edge is not deformed. If the sealing compound has not dried on, clean the rubber strip with naphtha, otherwise replace it.

FITTING THE WINDSCREEN

1. Place the windscreen on a stand as shown in Fig. 59. Moisten the outer edge of the windscreen and fit the rubber strip starting at one of the corners. Adjust the strip so that it lies correctly all round.

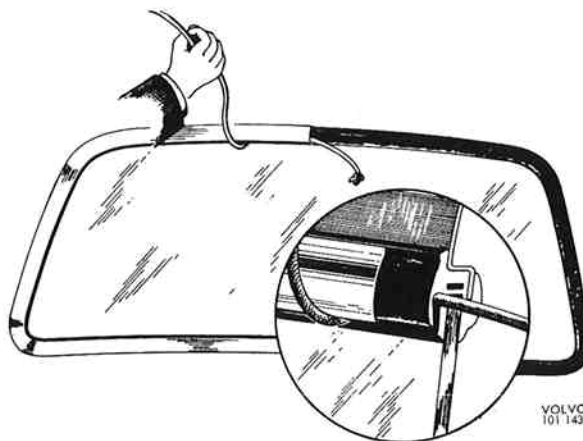

Fig. 56. Fitting trim moulding



Fig. 57. Releasing rubber strip

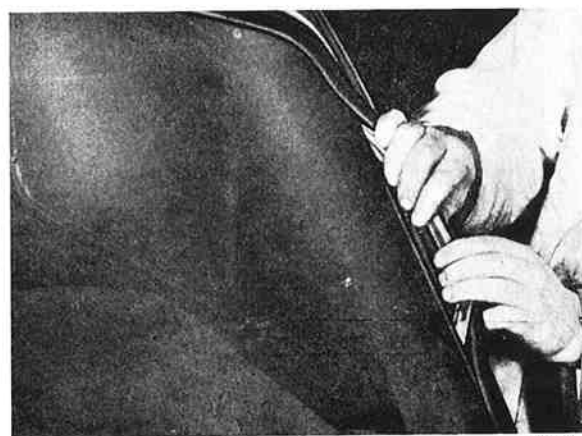
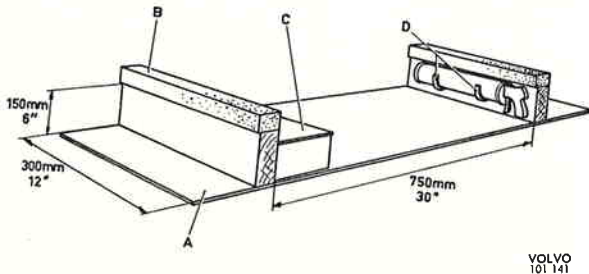

Fig. 58. Removing rubber strip



VOLVO
101 141

Fig. 59. Stand for windscreen when fitting rubber strip

- A. Sheet of plywood, 15 mm ($19/32$ "
- B. Foam plastic, 1—1 $1/2$ "
- C. Storage compartment
- D. Hooks for sealing compound gun

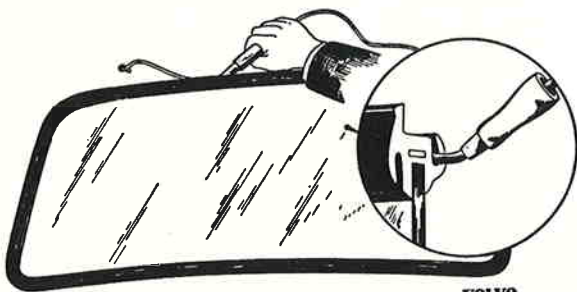

VOLVO
24817

Fig. 60. Placing cord in rubber strip

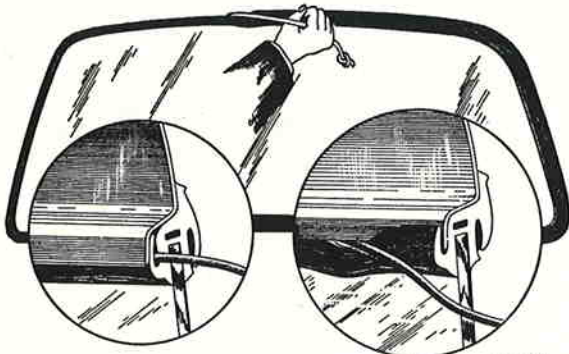

VOLVO
24822

Fig. 61. Fitting windscreen

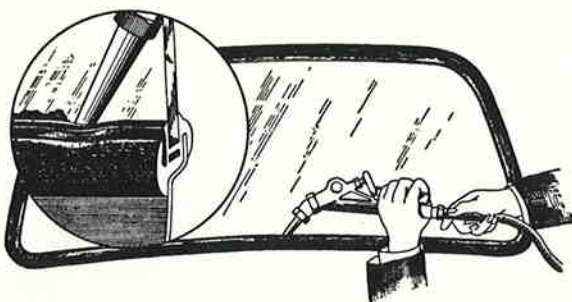

VOLVO
24813

Fig. 62. Applying sealing compound

2. Fit a cord (preferably terylene) of a suitable size in the groove of the rubber strip for the sheet metal edge, beginning at the top centre as shown in Fig. 60.
3. Place the windscreen in position with rubber strip fitted. Wearing working gloves, carefully strike the windscreen a few blows with the palm of the hand so that it makes good contact all round. Then carefully pull out the cord from inside.
4. This will cause the rubber strip to "creep" over the sheet metal edge as shown in Fig. 61. It may sometimes be necessary to adjust the position of the windscreen with the palm of the hand. If the cord is difficult to pull out, this may cause damage to the strip, in which case strike the windscreen from inside with the palm of the hand and vice versa if the rubber strip does not "creep" over the edge of the sheet metal properly.
5. Check that the rubber strip seals well all round. If necessary adjust the position of the windscreen both vertically and laterally by striking with the palm of the hand.
6. Fit the trim mouldings as previously described.
7. Seal the joints between the rubber strip and windscreen and rubber strip and sheet metal with sealing compound using a gun with a flat nylon nozzle as shown in Fig. 62. Make sure that the sealing compound fills the joint well. Scrape off surplus sealing compound and wash the windscreen and sheet metal with naphtha and then polish clean.
8. Fit the interior trim mouldings, rear view mirror and windscreen wiper arms.

Rear window

REMOVING AND FITTING

See the corresponding sections under the heading "Windscreen".

Rear ventilation window, 2-door model

REMOVING

Unscrew the two safety belt attaching bolts, remove the entry handle and lift off the cover plate, after which the ventilation window hinge screws are accessible, see Fig. 63.

SEATS

Front seats

REMOVING, EARLY PRODUCTION

Lift out the seat cushion. Press down the catch for adjusting the longitudinal position of the seat and push the seat forwards until the slide rails release from the frame. It may be necessary to lift the pull wire for the catch halfway between the slide rails. An intermediate production type has a plastic wedge which limits the movement of the catch. This wedge must be taken out before the seat can be removed.

REMOVING, LATE PRODUCTION

Unfasten the press-button which holds the seat cushion to the frame and remove the seat cushion. Unscrew the four attaching screws for the slide rails. Lift off the seat.

ADJUSTING THE FRONT SEAT, LATE PRODUCTION

1. The inclination of the seat is adjusted with the eyebolt (1, Fig. 64) at the front edge of the seat. Slacken the adjusting screw and adjust the eyebolt to the desired position.
2. The height of the seat is adjusted by attaching the rail in a suitable hole in the bracket (2).
3. The lumbar support is adjusted with the screw (3). On a number of earlier vehicles with lumbar support where the adjusting device does not have a countersink, the adjusting screw can most easily be found by pressing the upholstery at the adjusting screw hole slightly downwards and backwards.

Rear seat, Station Wagon

REMOVING THE BACKREST

Release the catch and tip the backrest slightly forwards. Move aside the nylon washer at the lower left-hand corner of the backrest and insert a narrow screwdriver as shown in Fig. 65. Press in the conical catch pin and lift out the backrest.

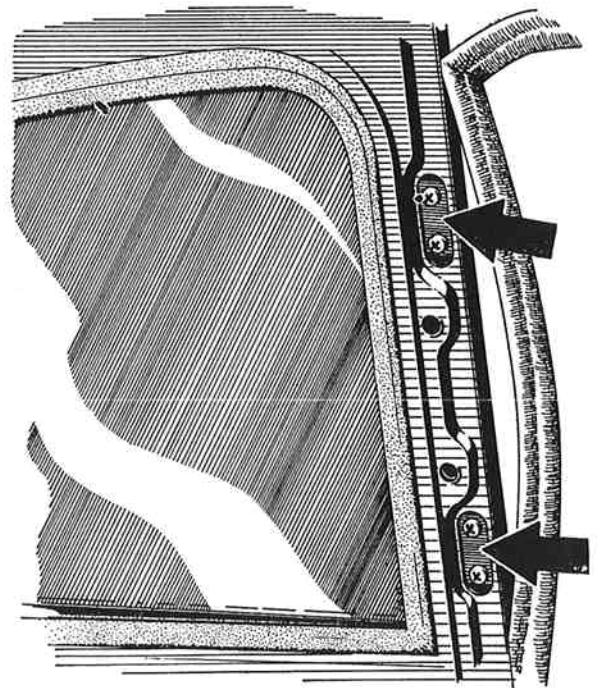

VOLVO
26227

Fig. 63. Attachment of rear ventilation window

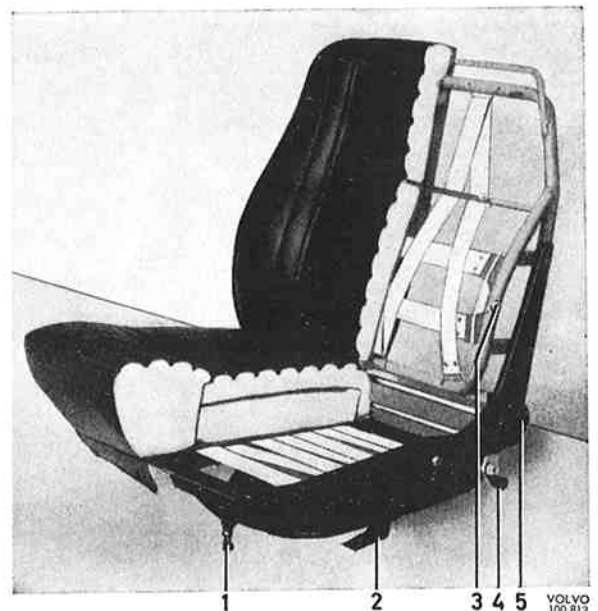
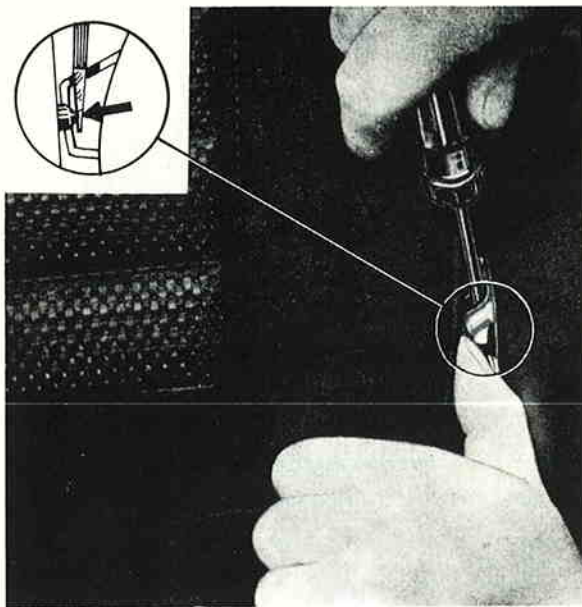

Fig. 64. Front seat

1. Adjustment of seat inclination
2. Adjustment of seat height
3. Adjustment of lumbar support
4. Longitudinal adjustment of seat
5. Adjustment of backrest inclination



VOLVO
101 028

Fig. 65. Releasing catch for removing rear seat backrest on Station Wagon

To remove the upholstery, undo the lacing at the lower edge, open the zip-fastener, after which the upholstery can be removed, see Fig. 66.

When fitting the backrest, place the nylon washer on the pin and fit the right-hand pin in position. Move the left-hand, conical pin towards the upper side of the fitting, move the nylon washer over the fitting and press down the seat. If necessary, the catch can be moved aside with a screwdriver.

REMOVING LOCK MECHANISM FOR BACKREST

The lock mechanism is accessible after the lacing at the lower edge of the backrest has been undone, the zip-fastener opened, see Fig. 66, and the upholstery removed.

UPHOLSTERY

Repairing inner roof (headlining)

STRETCHING THE HEADLINING FOR REMOVING SMALL HOLES AT THE OUTER EDGE

In most cases where there are small holes at the outer edge of the headlining it is sufficient just to stretch it.

1. Remove the interior light, sun visors, rear view mirror and upper part of the windscreen trim moulding. Remove the side mouldings as shown in Fig. 67.
2. Release the trim strip. Prise out the teazel strip with the help of a putty knife.
3. Pull out the trim strip as shown in Fig. 68 and remove the headlining from the teazel strip with the help of a putty knife.
4. Stretch the headlining so that the damaged part can be tucked in behind the teazel strip as shown in Fig. 69. The headlining should be stretched well, but not too hard so that it wrinkles.
5. Place the trim strip in position and knock the teazel strip against the side of the body with the help of a hammer and piece of rubber as shown in Fig. 70.
6. Fit the interior light, sun visors, rear view mirror and trim mouldings for the windscreen, see Fig. 71.

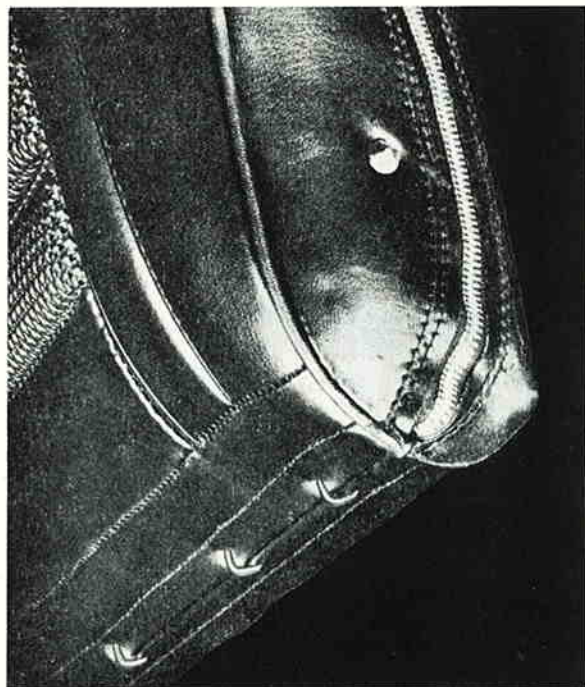

VOLVO
100 955

Fig. 66. Underside of rear seat backrest, Station Wagon

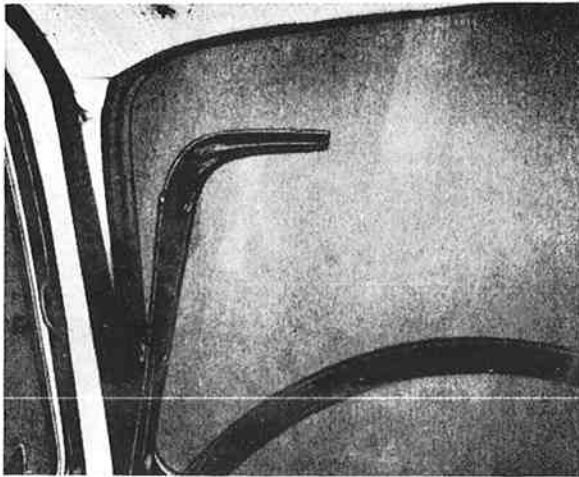

Fig. 67. Inner trim mouldings removed

VOLVO
100 859

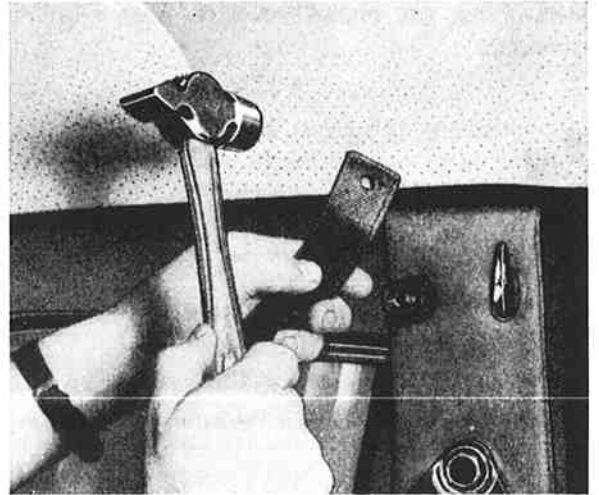

Fig. 70. Knocking in the teazel strip

VOLVO
100 857

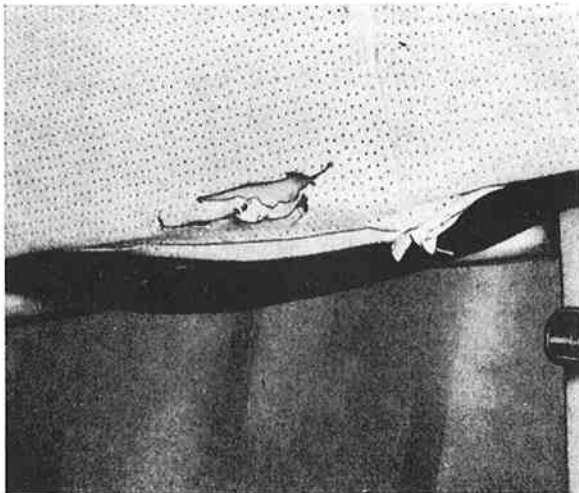

Fig. 68. Headlining and trim strip released

VOLVO
100 862

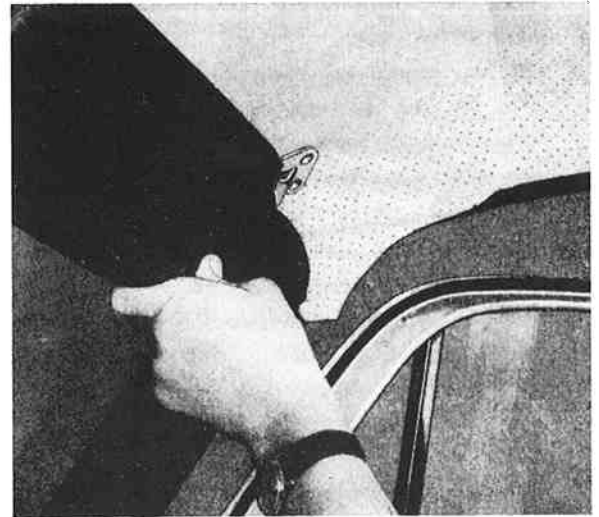

Fig. 71. Fitting sun visor

VOLVO
100 863

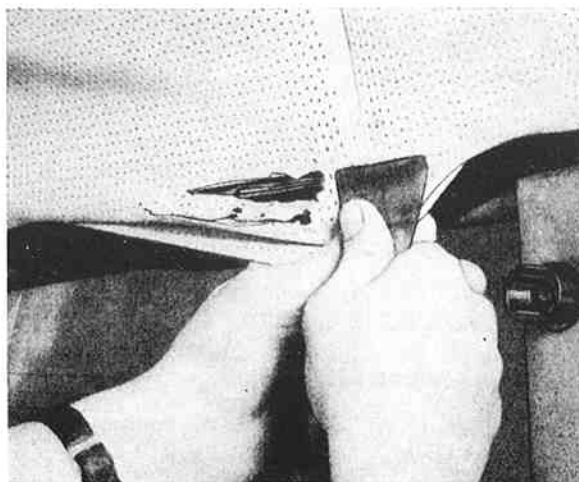

Fig. 69. Stretching the headlining

VOLVO
100 860

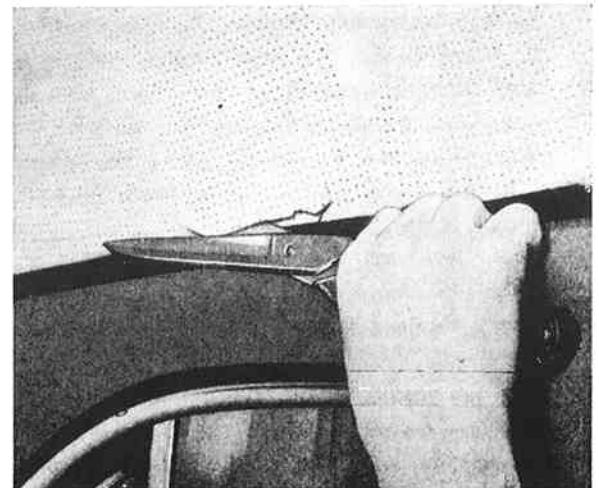

Fig. 72. Cutting away the headlining

VOLVO
100 858

REPLACING THE HEADLINING, 2- AND 4-DOOR VEHICLES

1. Remove the interior light, sun visors, rear view mirror and upper part of the trim moulding for the windscreen. Release the side mouldings as shown in Fig. 67.
2. Cut away the old headlining as shown in Fig. 72.
3. Remove the trim strip and remainder of the old headlining.
4. Adjust the teazel strip so that it fits well against the trim strip and check the screws of the teazel strip.
5. Fit the stretchers in the new headlining. N.B. The stretchers are numbered 1—5 with 1 at the front next to the windscreen. Make sure that the stretchers are provided with rubber caps at the ends.
6. Fit the headlining starting at the back, see Fig. 73. The rear stretchers are attached with clips, one on each side. The other stretchers are placed on the sheet metal edge over the doors. The stretchers should stand vertically.
7. Fold over the plastic strip and fit above the windscreen as shown in Fig. 74.
8. Fit the headlining above the rear window as described in point 7. The seam running across at the back should come at an equal distance from both the corners of the rear window, see Fig. 75.
9. Stick the headlining to the body metal at the rear window and to the wheel arch plate.
10. Fit the sun visors, see Fig. 71.
11. Stretch up the headlining in the teazel strip. This is done stretcher by stretcher beginning on both sides with stretcher 1, then stretcher 2, 3 and so on. The headlining is pushed in and **straight upwards** so that there are no creases at the windscreen or rear window. Do not secure the headlining along the whole side but leave a piece at the front edge as shown in Fig. 71.
12. Fit the trim strip.
13. Knock the teazel strip against the body side with a hammer and piece of rubber as shown in Fig. 70.
14. Cut out a hole for the interior light. Pull out the wires and fit the interior light.
15. Secure the remaining part of the headlining at the corners of the windscreen.
16. Fit the windscreen trim moulding.

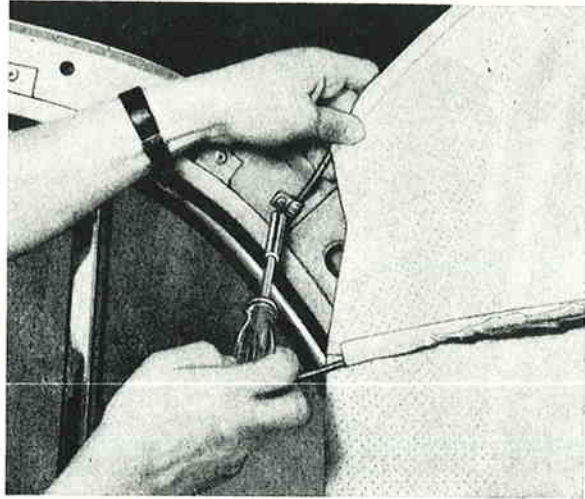

Fig. 73. Fitting rear clip

VOLVO
100 865

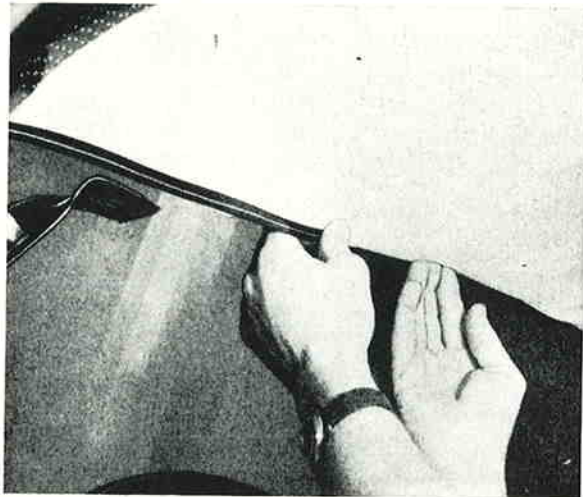

Fig. 74. Folding over and fitting the plastic strip

VOLVO
100 856

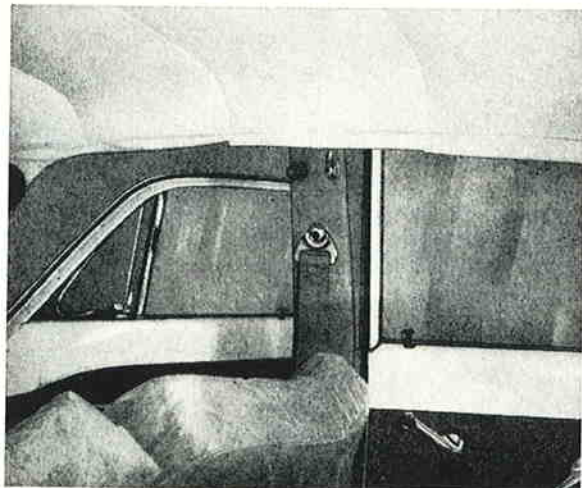
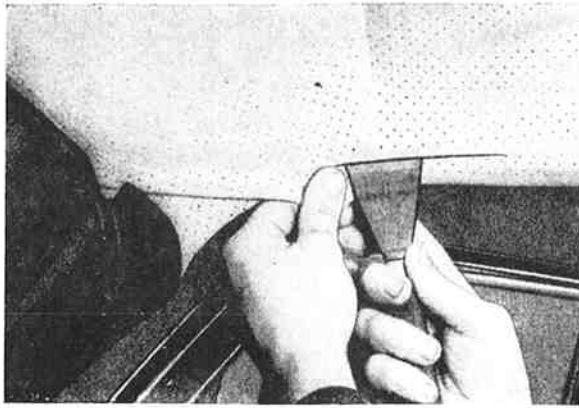

Fig. 75. Headlining ready for stretching

VOLVO
100 864



VOLVO
100 861

Fig. 76. Stretching the headlining and attaching to teazel strip

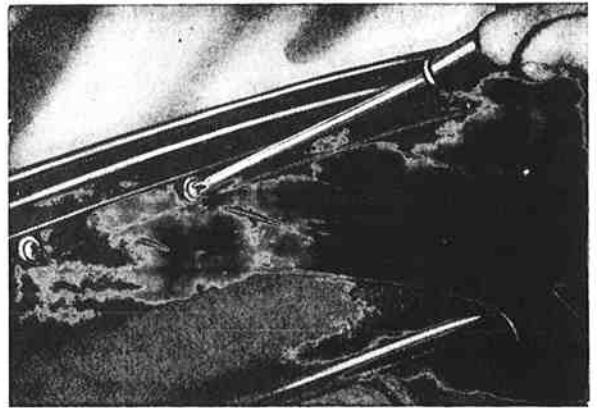

VOLVO
23251

Fig. 77. Removing trim moulding for windscreen

Instrument panel

REMOVING THE INSTRUMENT PANEL

The instrument panel is secured to the body with screws. These are accessible after the front doors have been opened and the inner trim moulding for the windscreen removed as shown in Fig. 77.

SPECIAL TOOLS FOR CARRYING OUT WORK ON THE BODY

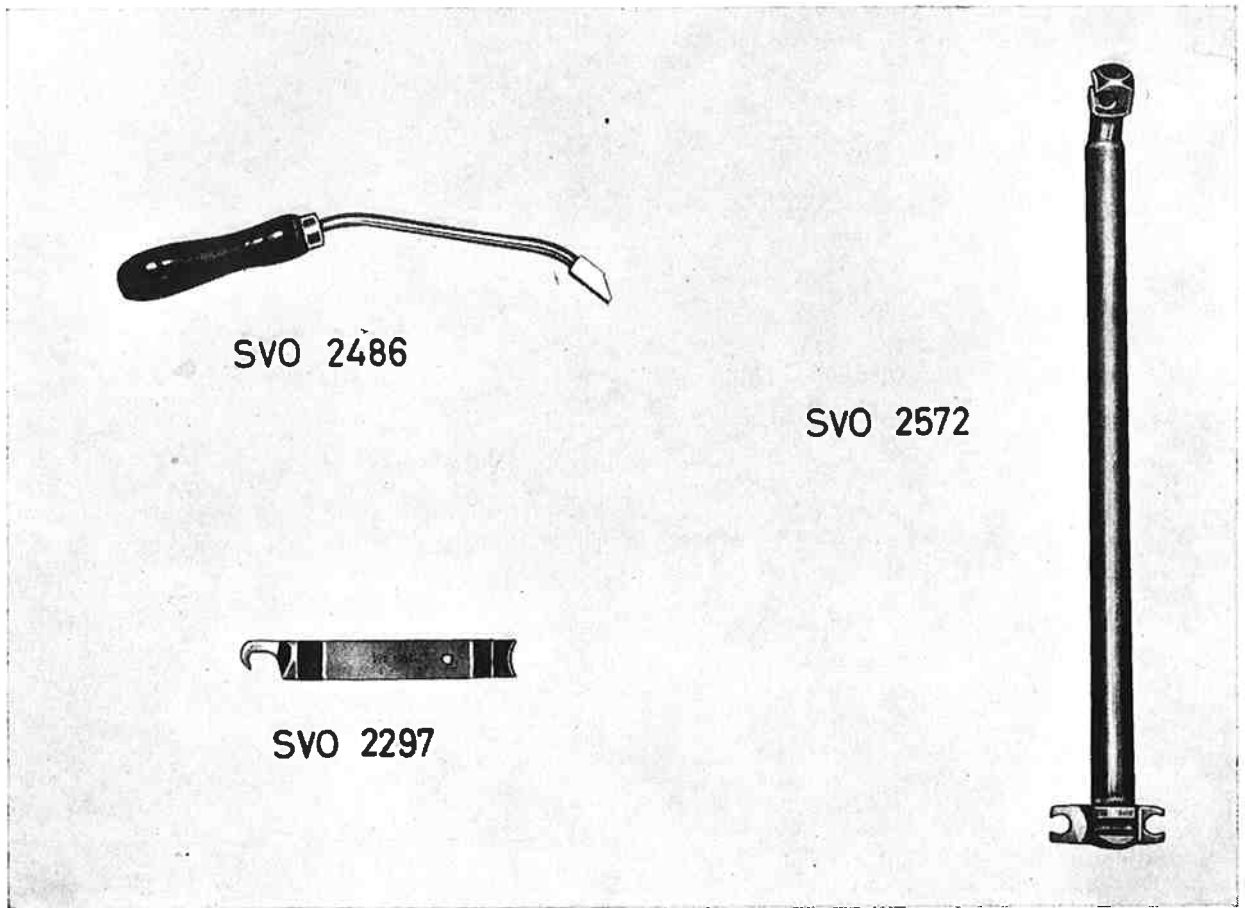

VOLVO
101 244

SVO 2297 Tool for removing clips on door and window winder handles, and for removing and fitting spring clips for window mouldings.

SVO 2486 Tool for fitting plate nut.
SVO 2572 Tool for removing and fitting torsion stay for luggage compartment lid.

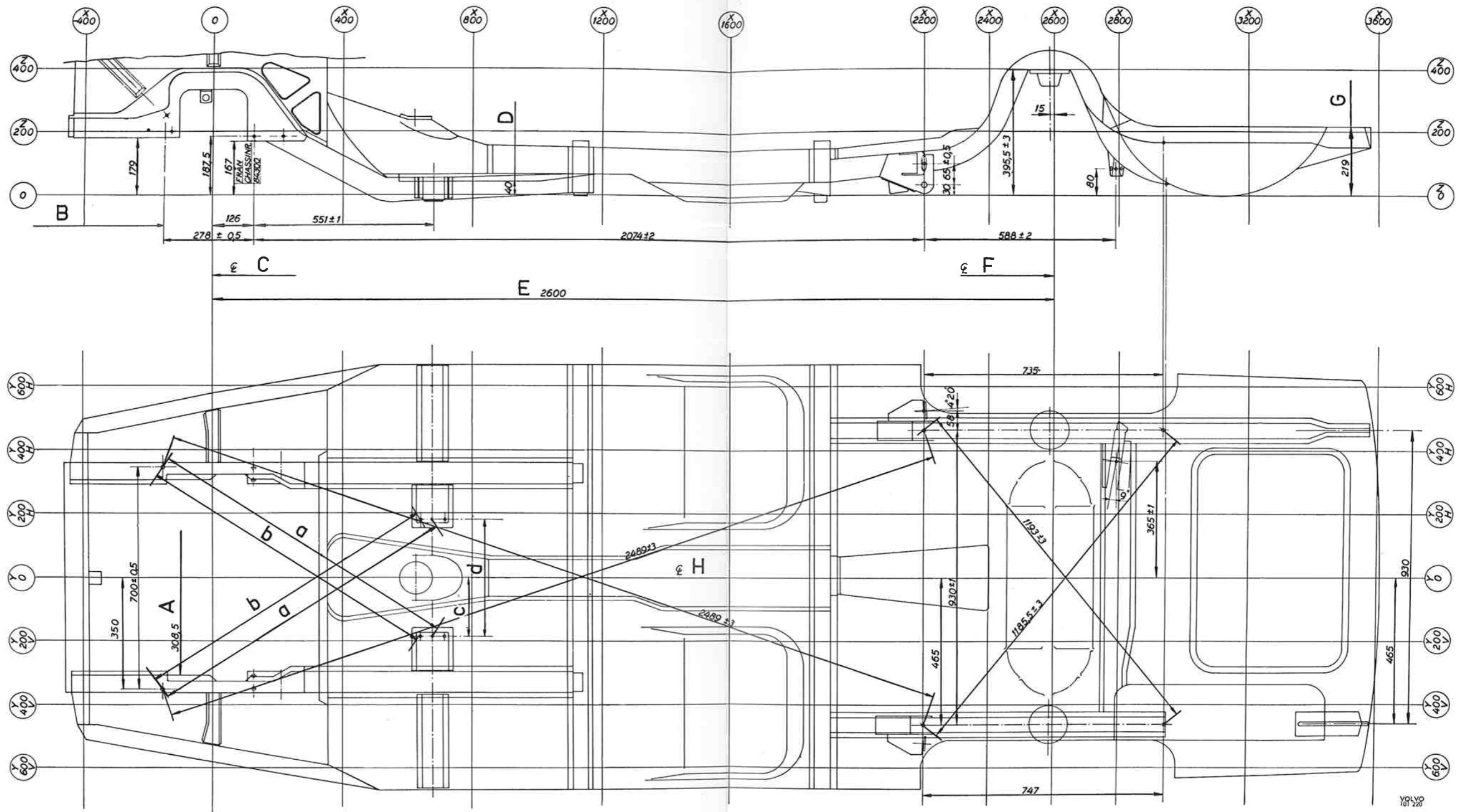

Illustration A. Control drawing for body floor, P 120 (2- and 4-door)

A=Plane of steering box
 B=Front attachment for front axle member
 C=Centre line of front axle member

D=Underside of floor at cantrail
 E=Wheelbase
 F=Centre line of rear axle
 G=Underside of floor
 H=Centre line of vehicle

P 120 — 4-door up to chassis number 139999
 P 120 — 2-door up to chassis number 3999

a
 b 938.5 ± 1.5
 c 154
 d 308 ± 0.5

With effect from chassis number 140000 For vehicles with automatic transmission:
 With effect from chassis number 40000

a 986 ± 1.5
 b 954.8 ± 1.5
 c 184
 d 368

a
 b 1106 ± 1.5
 c 184
 d 368

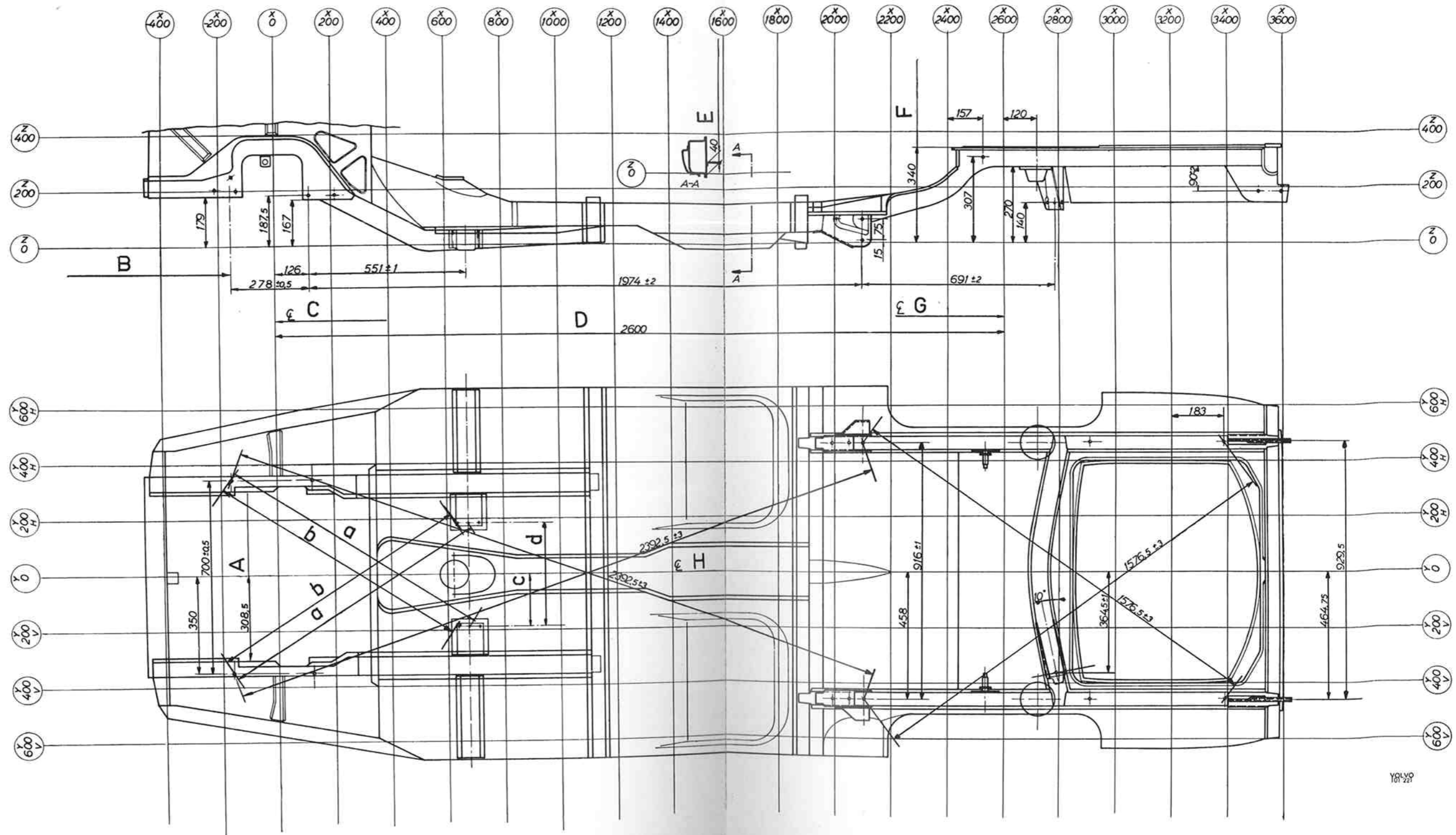

Illustration B. Control drawing for body floor, P 120 Station Wagon

- A = Plane of steering box
- B = Front attachment for front axle member
- C = Centre line of front axle member
- D = Wheelbase
- E = Underside of floor
- F = Underside of floor
- G = Centre line of rear axle
- H = Centre line of vehicle

Up to chassis number 8274

- a 938.5±1.5
- b 154
- d 308±0.5

With effect from chassis number 8275

- a 986±1.5
- b 954.8±1.5
- c 184
- d 368

